

Yes We Can!

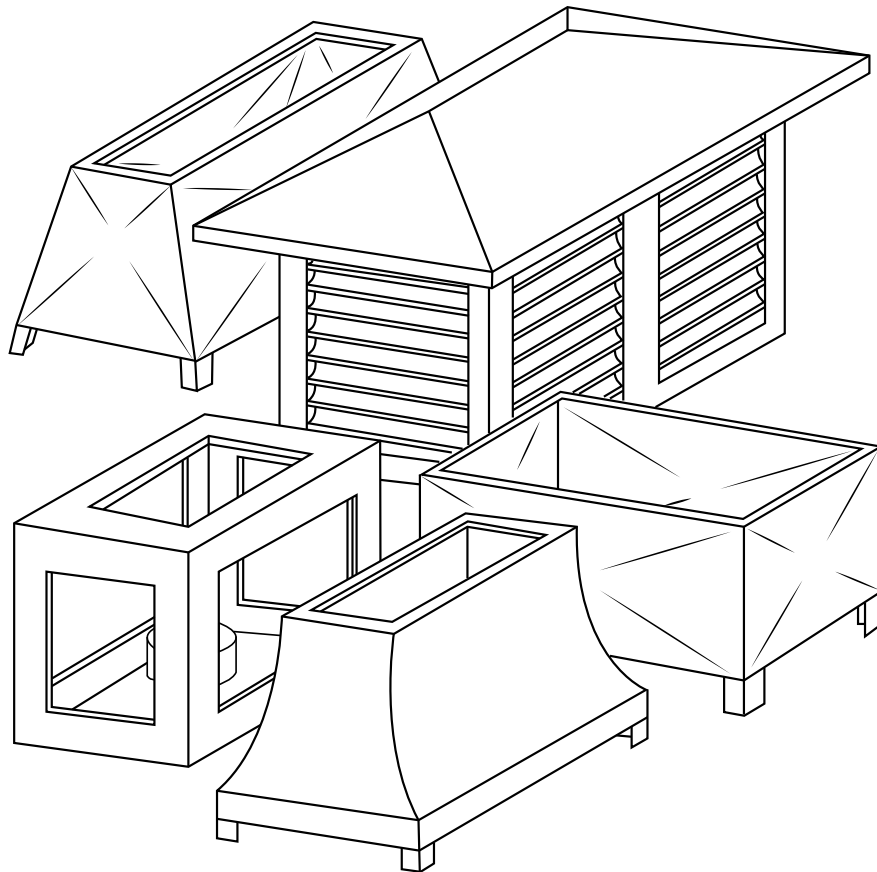

Product Catalog

Catalog Updates: acostamfg.com/products-and-submittals



acostamfg.com | sales@acostamfg.com

This document is digitally navigable—click on any of the links, items in the Table of Contents and Index, headers, footers, and you'll be taken to it's destination. **Note:** web links and emails will be opened in a new window.

(Stock) Product Catalog

Acosta Sheet Metal Mfg.©2024

Published October 14, 2024

Catalog Updates at www.acostamfg.com/products-and-submittals

Place an Order:

sales@acostamfg.com

www.acostamfg.com/place-order

Product Specification Sheets:

www.acostamfg.com/products-and-submittals

Contact Us:

sales@acostamfg.com

www.acostamfg.com

Phone (408) 766-7215

Sales Fax (408) 297-0130

930 Remillard Court

San Jose, CA 95122



Certified MBE



Table of Contents

Pipe

Acoustical Flex (with or without Damper)	8
Aluma Flex (Insulated or Bare)	9
Alumasprial Pipe	9
Duravent	10
Furnace Pipe	
KD/Snap Lock	11
Stitch Welded	12
Plenum and Cap	12
Riser Pipe	12
Spiral Pipe	13-14
Wire Flex (with or without collars)	15

Spiral

Spiral Elbow (45 and 90 Degree)	18
Spiral Collar	19
Spiral End Cap	20
Taper with Collar (for Spiral)	20
Hanger Strap	21
Duraflange	21
Spiral Pipe	22-23
Spiral-Helix Ovalizer Chart	24-25

Elbows

Adjustable (45 and 90 Degree)	28-29
Long Radius Adjustable (45 and 90 Degree)	30
Spiral Elbow (45 and 90 Degree)	30
Spot and Sealed Elbow (22.5, 45, and 90 Degree)	31

Wyes and Tees

Conical Tap	34
Self Stick Collar	34
Saddle Tap (Rectangular)	34
Saddle Tee	35
Tee	35
Vent Tee	35
Saddle Wye	36
Vent Wye	36
Stock Wye Branches	37

Table of Contents

HVAC Fittings and Accessories

Ceiling Box (Rectangular/Square)	40
Collar	41
Self-Stick Collar	41
Collar with Damper	42
Damper Blade/Disc	42
Blast Gate Damper	42
End Cap (Round)	43
Reducer	43
Taper	44
Taper with Collar	44
Taper with Collar (for Spiral)	45
Square to Round	45
F-5 Straight Boot	46
F-13 Angle Boot 90 Degree	46
F-17 Cone Boot	46
Fan Boot	47
PH 1	47
PH 2	48
PH	48
PH 3	49
Perimeter Box	49
Riser Elbow	50
F-1 Single Register Box	50
Fresh Air Vents	50
Rain Hoods	
“Old Style”	51
For wood	51
For stucco	51
Dust Cover	52
Dryer Vent	52
Perimeter Cover	52
Flue Bracket	52

Table of Contents

Gutter and Roofing

Gutter	54
End Cap	54
Gutter Strap	55
Leader/Conductor Pipe	55
Conductor/Leader Pipe Strap	56
Conductor Head	56
Conductor Elbow	56
Drop Outlet	56
Code Cap Bases	57
Code Cap Top	58
Roof Jacks/Fan Jacks	
Square Top	58
Kick Base	59
Lead Base	59
Regular Base	60
Shake Base	60
Roof Safe	60
Roof Flashings	
Flat	61
Pitch	62
Lead Base	62
China Cap	63
Draft Diverter	63
Eyebrow Vent	64
Gravity Vent	64
Gravity Vent Damper with Chain	65
Storm Collar	65
Angle Flashing (90 Degree)	66
Corner	66
Inside Corner	66
Gravel Stop	67
Nosing	67
Reglet	67
Ridge Flashing	68
Roofing Metals	68
Roof to Wall	68
Step Shingle	69

Table of Contents

W Valley	69
Z-Bar	69

Assorted Accessories

“S” and Drive Clip	72
Duct Liner and Pins	72
Duro Dyne Accessories	72
Flat Sheets	73
Insulation (Rolls)	74
Lead Rolls	74
Screws and Panduit Strap	74
Sealant and Solder	75
Strap	75
Tape, Glue, and Visqueen	75
Ceiling Register (Shoemaker)	76
Wall-Ceiling Register (Shoemaker)	76
Spiral Double Grille (Shoemaker)	76
Return-Air Filter Grille (Shoemaker)	77
T-Bar (Return and Supply Air)	77
Eave Vent	78
Foundation Vents	
Stucco	78
Flat	78
Gable Vent	79
Floor Vent (Shoemaker)	79

PIPEPRODUCTS

Assorted pipe for commercial and residential use







Yes We Can!

Acosta

Sheet Metal Manufacturing, Inc.









Phone (408) 275-6370
 Fax (408) 881-0177
 sales@acostamfg.com
 www.acostamfg.com

Acoustical Flex (without Damper)	Size	Item #		
 		<i>R-value 4.2</i>	<i>R-value 8</i>	<i>R-value 4.2</i>
		<i>Black Vinyl</i>	<i>Black Vinyl</i>	<i>Silver Vinyl</i>
Acoustical Flex (with Damper)	Size	Item #		
  		<i>R-value 4.2</i>	<i>R-value 8</i>	<i>R-value 4.2</i>
		<i>Black Vinyl</i>	<i>Black Vinyl</i>	<i>Silver Vinyl</i>
	5' Long			
6"	110-3106	110-3606	110-3306	
8"	110-3108	110-3608	110-3308	
10"	110-3110	110-3610	110-3310	
12"	110-3112	110-3612	110-3312	
14"	110-3114	110-3614	110-3314	
16"	110-3116	110-3616	110-3316	
18"	110-3118	110-3618	110-3318	
20"	110-3120	110-3620	110-3320	
		<ul style="list-style-type: none"> • Collars taped with 555 U.L. Duct Tape • 2" Water Column 		
		<ul style="list-style-type: none"> • Adjustable Collars • 2" Water Column 		

Yes We Can!

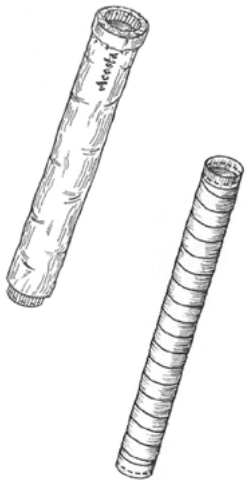

Phone (408) 275-6370
 Fax (408) 881-0177
 sales@acostamfg.com
 www.acostamfg.com

Aluma Flex (Insulated)	Size	Item #				
		R-value 4.2 Black Vinyl	R-value 4.2 Black Vinyl & Taped	R-value 8 Black Vinyl	Bare	
  					10' Long (without collars)	
	3".....				110-1103	
	4".....				110-1104	
	7.5' Long					(with collars)
	5".....	110-1205.....		110-1305.....	110-1105	
	6".....	110-1206.....	110-1406.....	110-1306.....	110-1106	
	7".....	110-1207.....		110-1307.....	110-1107	
	8".....	110-1208.....	110-1408.....	110-1308.....	110-1108	
	9".....	110-1209.....		110-1309.....	110-1109	
	10".....	110-1210.....	110-1410.....	110-1310.....	110-1110	
	12".....	110-1212.....	110-1412.....	110-1312.....	110-1112	
	14".....	110-1214.....	110-1414.....	110-1314.....	110-1114	
	16".....	110-1216.....	110-1416.....	110-1316.....	110-1116	
	18".....	110-1218.....	110-1418.....	110-1318.....	110-1118	
	20".....	110-1220.....	110-1420.....	110-1320.....	110-1120	
	22".....	110-1222.....	110-1422.....	110-1322.....	110-1122	
	24".....	110-1224.....	110-1424.....	110-1324.....	110-1124	
						<ul style="list-style-type: none"> • Collars glued and stapled • 10" water column
	Alumaspiral	Size	Item #			
	  		R-value 4.2 Silver Vinyl	Taped Silver Vinyl	Visqueened Silver Vinyl	
7.5' Long						
6".....		125-4206.....	125-4406.....	125-4306		
8".....		125-4208.....	125-4408.....	125-4308		
10".....		125-4210.....	125-4410.....	125-4310		
12".....		125-4212.....	125-4412.....	125-4312		
14".....		125-4214.....	125-4414.....	125-4314		
16".....		125-4216.....	125-4416.....	125-4316		
18".....		125-4218.....	125-4418.....	125-4318		
20".....		125-4220.....	125-4420.....	125-4320		
22".....		125-4222.....	125-4422.....	125-4322		
24".....		125-4224.....	125-4424.....	125-4324		

Phone (408) 275-6370
 Fax (408) 881-0177
 sales@acostamfg.com
 www.acostamfg.com

Yes We Can!



Duravent (Double Wall)	Size	Item #		
		3"	4"	5"
			D.W. Pipe 12" Long.....	380-3112.....
D.W. Pipe 12" Long Adjustable.....	380-3212.....		380-4212.....	380-5212
D.W. Pipe 18" Long.....	380-3118.....		380-4118.....	380-5118
D.W. Pipe 24" Long.....	380-3124.....		380-4124.....	380-5124
D.W. Pipe 36" Long.....	380-3136.....		380-4136.....	380-5136
D.W. Pipe 48" Long.....	380-3148.....		380-4148.....	380-5148
D.W. Pipe 60" Long.....	380-3160.....		380-4160.....	380-5160
45 Degree Elbow.....	380-3304.....		380-4304.....	380-5204
90 Degree Elbow.....	380-3309.....		380-4309.....	380-5309
D.W. Storm Collar.....	380-3605.....		380-4605.....	380-5605
D.W. Tee.....	380-3405.....		380-4405.....	380-5405
D.W. Tee Cap.....	380-3410.....		380-4410.....	380-5410
D.W. Vent Top.....	380-3610.....		380-4610.....	380-5610
			6"	8"
D.W. Pipe 12" Long.....	380-6112.....		380-8112	
D.W. Pipe 12" Long Adjustable.....	380-6212.....		380-8212	
D.W. Pipe 18" Long.....	380-6118.....		380-8118	
D.W. Pipe 24" Long.....	380-6124.....		380-8124	
D.W. Pipe 36" Long.....	380-6136.....	380-8136		
D.W. Pipe 48" Long.....	380-6148.....	380-8148		
D.W. Pipe 60" Long.....	380-6160.....	380-8160		
45 Degree Elbow.....	380-6304.....	380-8304		
90 Degree Elbow.....	380-6309.....	380-8309		
D.W. Storm Collar.....	380-6605.....	380-8605		
D.W. Tee.....	380-6405.....	380-8405		
D.W. Tee Cap.....	380-6410.....	380-8410		
D.W. Vent Top.....	380-6610.....	380-8610		

Yes We Can!

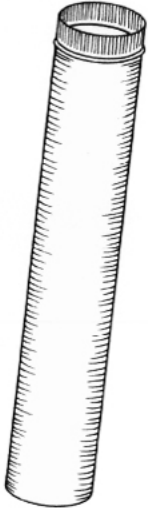

Phone (408) 275-6370
 Fax (408) 881-0177
 sales@acostamfg.com
 www.acostamfg.com

Furnace Pipe (KD/Snap Lock)	Size	Item #			
		<i>Galvanized Steel 26 Gauge 3' Long</i>	<i>Galvanized Steel 24 Gauge 3' Long</i>	<i>Galvanized Steel 26 Gauge 5' Long</i>	
	3"	113-1203			
	4"	113-1204		115-1204	
	5"	113-1205		115-1205	
	6"	113-1206		115-1206	
	7"	113-1207		115-1207	
	8"	113-1208		115-1208	
	9"	113-1209		115-1209	
	10"	113-1210		115-1210	
	12"	113-1212		115-1212	
	14"	113-1214		115-1214	
	16"		113-1316		
	18"		113-1318		
	20"		113-1320		
	22"		113-1322		
	24"		113-1324		
	26"		113-1326		
			304 2B Stainless Steel	0.025 Aluminum	
		<i>3' Long</i>			
		3"	113-2203		114-5203
		<i>4' Long</i>			
		4"	114-2204		114-5204
		5"	114-2205		114-5205
		6"	114-2206		114-5206
		7"	114-2207		114-5207
		8"	114-2208		114-5208
		10"	114-2210		114-5210
	12"	114-2212		114-5212	
	14"	114-2214		114-5214	

Yes We Can!

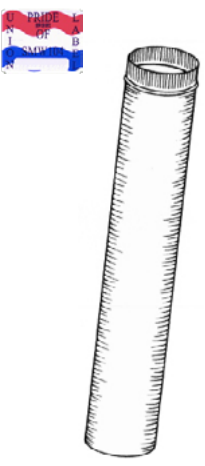
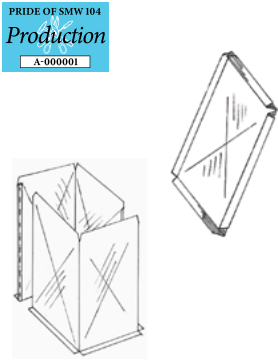
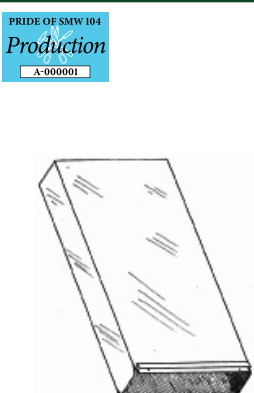

Phone (408) 275-6370
 Fax (408) 881-0177
 sales@acostamfg.com
 www.acostamfg.com

<p>Furnace Pipe (Stitch Welded)</p> 	<p>Size Item #</p> <p style="text-align: center;"><i>316 2B Stainless Steel 24 Gauge</i></p> <p><i>4' Long</i></p> <p>4"114-2104 6"114-2106 8"114-2108 10"114-2110 12"114-2112 14"114-2114</p>
<p>Plenum and Cap</p> 	<p>Size Item #</p> <p style="text-align: center;"><i>Galvanized Steel 26 Gauge</i></p> <p>13.5" x 20" x 35.5" & 0.5" Flange.....PM13520 16.5" x 20" x 35.5" & 0.5" Flange.....PM16520 19.75" x 20" x 35.5" & 0.5" Flange.....PM197520</p>
<p>Riser Pipe</p> 	<p>Size Item #</p> <p style="text-align: center;"><i>Galvanized Steel 26 Gauge</i></p> <p><i>5' Long</i></p> <p>3.25"x10"210-1010 3.25"x12"210-1012 3.25"x14"210-1014</p> <p>• Available in special order sizes, lengths, and gauges.</p>

Yes We Can!

Acosta

Sheet Metal Manufacturing, Inc.

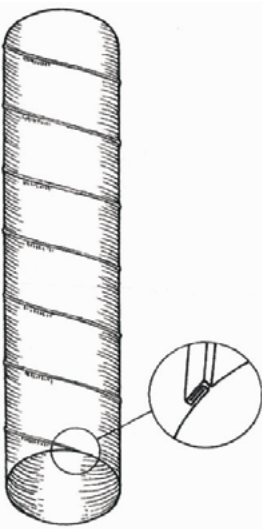

Phone (408) 275-6370
 Fax (408) 881-0177
 sales@acostamfg.com
 www.acostamfg.com

Spiral Pipe	Size	Item #			
		Galvanized Steel 10' Long	"Visqueen" 10' Long	8' Long	"Visqueen" 8' Long
	26 Gauge				
	3"	125-1203			
	4"	125-1204	125-5204		
	5"	125-1205			
	6"	125-1206	125-5206	125-1606	125-5006
	7"	125-1207			
	8"	125-1208	125-5208	125-1608	125-5008
	9"	125-1209			
	10"	125-1210	125-5210	125-1610	125-5010
	12"	125-1212	125-5212	125-1612	125-5012
	14"	125-1214	125-5214	125-1614	125-5014
	24 Gauge				
	4"	125-1304			
	6"	125-1306			
	8"	125-1308			
	10"	125-1310			
	12"	125-1312			
	14"	125-1314			
	16"	125-1316	125-5316	125-1716	125-5016
	18"	125-1318	125-5318	125-1718	125-5018
	20"	125-1320	125-5320	125-1720	125-5020
	22"	125-1322	125-5322		
	24"	125-1324	125-5324		
	26"	125-1326	125-5326		
	22 Gauge				
	28"	125-1428	125-5428		
	30"	125-1430	125-5430		
	32"	125-1432	125-5432		
	34"	125-1434	125-5434		
	36"	125-1436	125-5436		
Sizes from 38"-64" are made-to-order.					
20' lengths are made-to-order.					

Yes We Can!

Acosta

Sheet Metal Manufacturing, Inc.

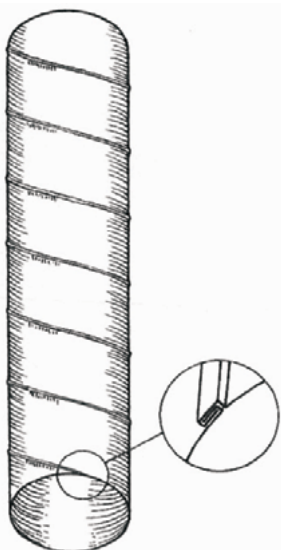

Phone (408) 275-6370
 Fax (408) 881-0177
 sales@acostamfg.com
 www.acostamfg.com

Spiral Pipe	Size	Item #
 		<p style="text-align: center;">304 2B Stainless Steel</p> <p style="text-align: center;">0.025 Aluminum</p> <p style="text-align: center;">316 2B Stainless Steel</p>
	<p>10' Long</p> <p>24 Gauge</p> <p>3".....125-2203</p> <p>4".....125-2204.....125-3404</p> <p>6".....125-2206.....125-5506.....125-3406</p> <p>8".....125-2208.....125-5508.....125-3408</p> <p>10".....125-2210.....125-5510.....125-3410</p> <p>12".....125-2212.....125-5512.....125-3412</p> <p>14".....125-2214.....125-5514.....125-3414</p> <p>16".....125-2316.....125-3416</p> <p>18".....125-2318.....125-3418</p> <p>20".....125-2320.....125-3420</p> <p>22".....125-2322.....125-3422</p> <p>24".....125-2324.....125-3424</p> <p>26".....125-2326.....125-3426</p> <p>22 Gauge</p> <p>28".....125-2428</p> <p>30".....125-2430</p>	
	<p>Sizes from 38"-64" are made-to-order.</p>	





Yes We Can!

Acosta

Sheet Metal Manufacturing, Inc.



Phone (408) 275-6370
 Fax (408) 881-0177
 sales@acostamfg.com
 www.acostamfg.com

Wire Flex (without Collars)	Size	Item #			
 		4.2 R-Value	6 R-Value (Silver Jacket Only)		
	25' Long				
	4"	110-2204.....	110-2504		
	5"	110-2205.....	110-2505		
	6"	110-2206.....	110-2506		
	7"	110-2207.....	110-2507		
	8"	110-2208.....	110-2508		
	9"	110-2209.....	110-2509		
	10"	110-2210.....	110-2510		
	12"	110-2212.....	110-2512		
	14"	110-2214.....	110-2514		
	16"	110-2216.....	110-2516		
	18"	110-2218.....	110-2518		
	20"	110-2220.....	110-2520		
			<ul style="list-style-type: none"> • 10" water column 		
Wire Flex (with Collars)	Size	Item #			
  		4.2 R-Value	8 R-Value (Silver Jacket Only)	4.2 R-Value with damper	
	5' Long				
	4"	110-2004.....	110-3804		
	5"	110-2005.....	110-3805		
	6"	110-2006.....	110-3806.....	110-2306	
	7"	110-2007.....	110-3807		
	8"	110-2008.....	110-3808.....	110-2308	
	9"	110-2009.....	110-3809		
	10"	110-2010.....	110-3810.....	110-2310	
	12"	110-2012.....	110-3812.....	110-2312	
	14"	110-2014.....	110-3814.....	110-2314	
	16"	110-2016.....	110-3816.....	110-2316	
	18"	110-2018.....	110-3818.....	110-2318	
	20"	110-2020.....	110-3820.....	110-2320	
			<ul style="list-style-type: none"> • Collars taped with 555 U.L. Duct tape • 10" water column 		

This page intentionally left blank

SPIRAL PRODUCTS

Assorted Spiral Pipe and accessories



Yes We Can!

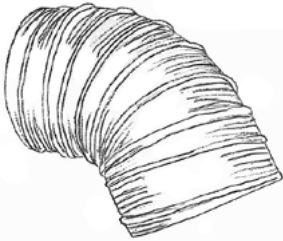
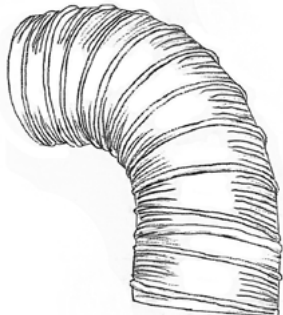

Phone (408) 275-6370
 Fax (408) 881-0177
 sales@acostamfg.com
 www.acostamfg.com

Spiral Elbow 45 Degree	Size	Item #		
		Short Radius	Long Radius	
	24 Gauge			
	6".....	152-1206.....	154-1206	
	8".....	152-1208.....	154-1208	
	10".....	152-1210.....	154-1210	
	12".....	152-1212.....	154-1212	
	14".....	152-1214.....	154-1214	
	16".....	152-1316.....	154-1316	
	18".....	152-1318.....	154-1318	
	20".....	152-1320.....	154-1320	
	22".....	152-1322.....	154-1322	
	24".....	152-1324.....	154-1324	
	Spiral Elbow 90 Degree	Size	Item #	
		Short Radius	Long Radius	
	24 Gauge			
	6".....	153-1206.....	155-1206	
	8".....	153-1208.....	155-1208	
	10".....	153-1210.....	155-1210	
	12".....	153-1212.....	155-1212	
	14".....	153-1214.....	155-1214	
	16".....	153-1316.....	155-1316	
	18".....	153-1318.....	155-1318	
	20".....	153-1320.....	155-1320	
	22".....	153-1322.....	155-1322	
	24".....	153-1324.....	155-1324	

Phone (408) 275-6370
 Fax (408) 881-0177
 sales@acostamfg.com
 www.acostamfg.com

Yes We Can!



Spiral Collar	Size	Item #			
		Galvanized	304 2B Stainless	0.025 Aluminum	
	26 Gauge				
	3"	180-3003	180-3103		
	4"	180-3004	180-3104		
	5"	180-3005			
	6"	180-3006	180-3106	180-3206	
	7"	180-3007			
	8"	180-3008	180-3108	180-3208	
	9"	180-3009			
	10"	180-3010	180-3110	180-3210	
	12"	180-3012	180-3112	180-3212	
	14"	180-3014	180-3114	180-3214	
	24 Gauge				
	16"	180-3016	180-3116		
	18"	180-3018	180-3118		
	20"	180-3020			
	22"	180-3022			
	24"	180-3024			
	26"	180-3026			
	22 Gauge				
	28"	180-3028			
	30"	180-3030			
	32"	180-3032			
	34"	180-3034			
	36"	180-3036			
	<p>Sizes from 38"-64" are available upon request.</p>				
	<p>• 10" water column</p>				



Yes We Can!

Acosta

Sheet Metal Manufacturing, Inc.

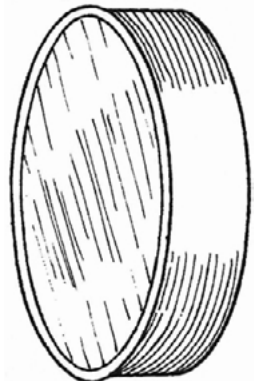

Phone (408) 275-6370
 Fax (408) 881-0177
 sales@acostamfg.com
 www.acostamfg.com

Spiral End Cap	Size	Item #	
 	26 Gauge		
	4".....	185-1104	
	5".....	185-1105	
	6".....	185-1106	
	7".....	185-1107	
	8".....	185-1108	
	9".....	185-1109	
	10".....	185-1110	
	12".....	185-1112	
	14".....	185-1114	
	24 Gauge		
	16".....	185-1116	
	18".....	185-1118	
	20".....	185-1120	
	22".....	185-1122	
	24".....	185-1124	
	26".....	185-1126	
	Spiral Taper with Collar	Size	Item #
	 	24 Gauge	24 Gauge
		6-4".....	190-2144
8-4".....		190-2147	18-16".....190-2166
8-6".....		190-2146	20-16".....190-2169
10-6".....		190-2159	20-18".....190-2168
10-8".....		190-2158	22-18".....190-2196
12-8".....		190-2161	22-20".....190-2194
12-10".....		190-2160	24-20".....190-2192
14-10".....		190-2173	24-22".....190-2190
14-12".....		190-2172	
16-12".....		190-2186	
16-14".....		190-2184	
<ul style="list-style-type: none"> • 3" wide collars, 6" long body 			

Yes We Can!



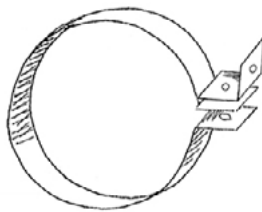
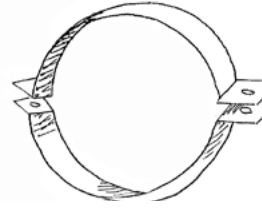
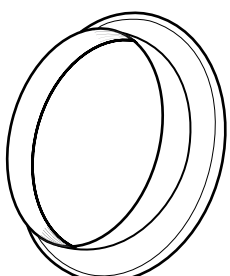

Phone (408) 275-6370
 Fax (408) 881-0177
 sales@acostamfg.com
 www.acostamfg.com

Hanger Strap	Size	Item #
  	1-Piece	
	<p><i>16 Gauge</i></p> <p>6" 290-1606</p> <p>8" 290-1608</p> <p>10" 290-1610</p> <p>12" 290-1612</p> <p>14" 290-1614</p> <p>16" 290-1616</p> <p>18" 290-1618</p> <p>20" 290-1620</p> <p>22" 290-1622</p> <p>24" 290-1624</p>	
	2-Piece	
<p><i>16 Gauge*</i></p> <p>16" 290-1716</p> <p>18" 290-1718</p> <p>20" 290-1720</p> <p>22" 290-1722</p> <p>24" 290-1724</p>		
Duraflange	Size	Item #
	<i>16 Gauge</i>	
	6" 181-5006	
	8" 181-5008	
	10" 181-5010	
	12" 181-5012	
	14" 181-5014	
	16" 181-5016	
	18" 181-5018	
	20" 181-5020	
	22" 181-5022	
24" 181-5024		

Yes We Can!



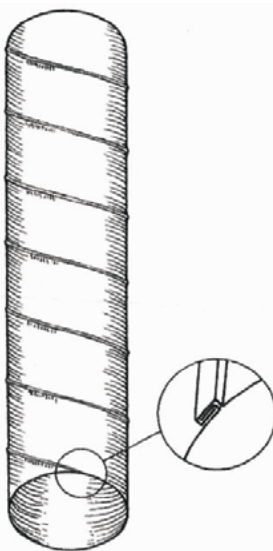

Phone (408) 275-6370
 Fax (408) 881-0177
 sales@acostamfg.com
 www.acostamfg.com

Spiral Pipe	Size	Item #			
		Galvanized Steel 10' Long	"Visqueen" 10' Long	8' Long	"Visqueen" 8' Long
  	26 Gauge				
	3"	125-1203			
	4"	125-1204	125-5204		
	5"	125-1205			
	6"	125-1206	125-5206	125-1606	125-5006
	7"	125-1207			
	8"	125-1208	125-5208	125-1608	125-5008
	9"	125-1209			
	10"	125-1210	125-5210	125-1610	125-5010
	12"	125-1212	125-5212	125-1612	125-5012
	14"	125-1214	125-5214	125-1614	125-5014
	24 Gauge				
	4"	125-1304			
	6"	125-1306			
	8"	125-1308			
	10"	125-1310			
	12"	125-1312			
	14"	125-1314			
	16"	125-1316	125-5316	125-1716	125-5016
	18"	125-1318	125-5318	125-1718	125-5018
	20"	125-1320	125-5320	125-1720	125-5020
	22"	125-1322	125-5322		
	24"	125-1324	125-5324		
	26"	125-1326	125-5326		
	22 Gauge				
	28"	125-1428	125-5428		
	30"	125-1430	125-5430		
	32"	125-1432	125-5432		
	34"	125-1434	125-5434		
	36"	125-1436	125-5436		
	Sizes from 38"-64" are made-to-order.				
	20' lengths are made-to-order.				

Phone (408) 275-6370
 Fax (408) 881-0177
 sales@acostamfg.com
 www.acostamfg.com

Yes We Can!

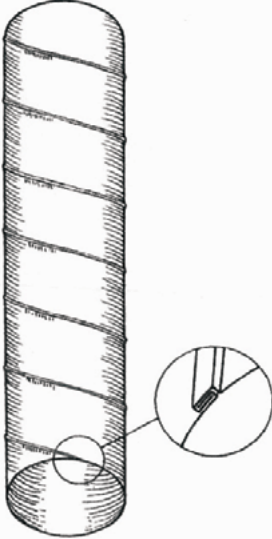

Spiral Pipe	Size	Item #	
		304 2B Stainless Steel	0.025 Aluminum 316 2B Stainless Steel
  	10' Long		
	24 Gauge		24 Gauge
	3".....	125-2203	
	4".....	125-2204	125-3404
	6".....	125-2206	125-5506.....125-3406
	8".....	125-2208	125-5508.....125-3408
	10".....	125-2210	125-5510.....125-3410
	12".....	125-2212	125-5512.....125-3412
	14".....	125-2214	125-5514.....125-3414
	16".....	125-2316	125-3416
	18".....	125-2318	125-3418
	20".....	125-2320	125-3420
	22".....	125-2322	125-3422
	24".....	125-2324	125-3424
	26".....	125-2326	125-3426
	22 Gauge		
	28".....	125-2428	
	30".....	125-2430	

Sizes from 38"-64" are made-to-order.

Yes We Can!

Acosta

Sheet Metal Manufacturing, Inc.



Phone (408) 275-6370
 Fax (408) 881-0177
 sales@acostamfg.com
 www.acostamfg.com



Spiral-Helix Ovalizer Chart

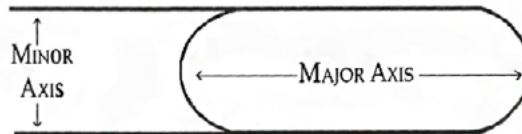

Minor Axis Size of Oval Spiral Pipe

Round Spiral Pipe Circumference

	6"	8"	10"	12"	14"	16"	18"	20"	22"	24"
14"	18.8	17.7								
16"	22.0	20.9	19.8	18.6						
18"	25.1	24.1	22.9	21.8	20.6					
20"	28.3	27.2	26.1	24.9	23.8	22.7				
22"	31.5	30.4	29.3	28.1	27.0	25.8	24.7			
24"	34.6	33.6	32.4	31.3	30.1	29.0	27.9	26.7		
26"	37.8	36.7	35.6	34.4	33.3	32.2	31.0	29.9	28.7	
28"	40.9	39.9	38.7	37.6	36.5	35.3	34.2	33.0	31.9	30.7
30"	44.1	43.0	41.9	40.8	39.6	38.5	37.3	36.2	35.1	33.9
32"	47.3	46.2	45.1	43.9	42.8	41.6	40.5	39.4	38.2	37.1
34"	50.4	49.4	48.2	47.1	46.0	44.8	43.7	42.5	41.4	40.2
36"	53.6	52.5	51.4	50.3	49.1	48.0	46.8	45.7	44.5	43.4
38"	56.8	55.7	54.6	53.4	52.3	51.1	50.0	48.5	47.7	46.6
40"	59.9	58.9	57.7	56.6	55.4	54.3	53.2	52.0	50.9	49.7
42"	63.1	62.0	60.9	59.7	58.6	57.5	56.3	55.2	54.0	52.9

Final Measurement of Major Axis (in inches)

Yes We Can!

Acosta

Sheet Metal Manufacturing, Inc.



Phone (408) 275-6370
 Fax (408) 881-0177
 sales@acostamfg.com
 www.acostamfg.com



Spiral-Helix Ovalizer Chart

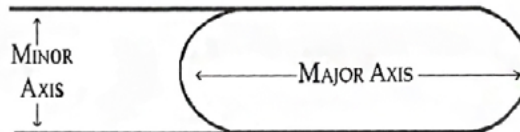

Minor Axis Size of Oval Spiral Pipe

	6"	8"	10"	12"	14"	16"	18"	20"	22"	24"
44"	66.3	65.2	64.1	62.9	61.8	60.6	59.5	58.3	57.2	56.1
46"	71.4	68.3	67.2	66.1	64.9	63.8	62.7	61.5	60.4	59.2
48"	72.6	71.5	70.4	69.2	68.1	67.0	65.8	64.7	63.5	62.4
50"	75.7	74.7	73.5	72.4	71.3	70.1	69.0	67.8	66.7	65.6
52"	78.9	77.8	76.7	75.6	74.4	73.3	72.1	70.9	69.9	68.7
54"	82.1	81.0	79.9	78.7	77.6	76.5	75.3	74.2	73.0	71.9
56"	85.2	84.2	83.0	81.9	80.7	79.6	78.5	77.3	76.2	75.0
58"			86.2	85.1	83.9	82.8	81.6	80.5	79.3	78.2
60"					87.1	85.9	84.8	83.7	82.5	81.4
62"	Final Measurement of Major Axis (in inches)					89.1	88.0	86.8	85.7	84.5
64"							91.1	90.0	88.8	87.7

Round Spiral Pipe Circumference

This page intentionally left blank

ELBOWS PRODUCTS

Assorted elbows for commercial and residential needs



Phone (408) 275-6370
 Fax (408) 881-0177
 sales@acostamfg.com
 www.acostamfg.com

Yes We Can!

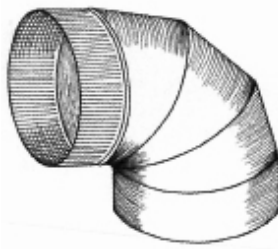

Adjustable Elbow 90 Degree	Size	Item #			
		Galvanized 26 Gauge	Galvanized 24 Gauge	Galvanized 22 Gauge	304 2B Stainless 26 Gauge
	3"	131-1203			131-2203
	4"	131-1204	131-1304		131-2204
	5"	131-1205	131-1305		131-2205
	6"	131-1206	131-1306		131-2206
	7"	131-1207	131-1307		131-2207
	8"	131-1208	131-1308		131-2208
	9"	131-1209	131-1309		131-2209
	10"	131-1210	131-1310		131-2210
	12"	131-1212	131-1312		131-2212
	14"	131-1214	131-1314		131-2214
	16"		131-1316		(24 gauge) 131-2216
	18"		131-1318		
	20"		131-1320		
	22"		131-1322		
	24"		131-1324		
26"		131-1326			
	28"			131-1428	
	30"			131-1430	
	32"			131-1432	
	34"			131-1434	
		<i>0.025 Aluminum</i>	<i>316 2B Stainless 24 Gauge</i>		
	3"	131-5203			131-2303
	4"	131-5204			131-2304
5"	131-5205			131-2305	
6"	131-5206			131-2306	
7"	131-5207			131-2307	
8"	131-5208			131-2308	
9"	131-5209			131-2309	
10"	131-5210			131-2310	
12"	131-5212			131-2312	
14"	131-5214			131-2314	

• Riveted construction with uniform crimping at one end.

Phone (408) 275-6370
 Fax (408) 881-0177
 sales@acostamfg.com
 www.acostamfg.com

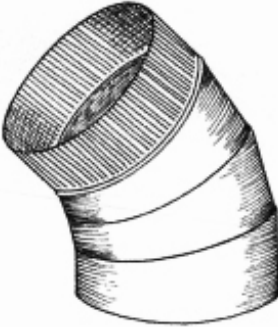

Adjustable Elbow 45 Degree	Size	Item #			
		Galvanized 26 Gauge	Galvanized 24 Gauge	Galvanized 22 Gauge	304 2B Stainless 26 Gauge
	3"	130-1203			130-2203
	4"	130-1204	130-1304		130-2204
	5"	130-1205	130-1305		130-2205
	6"	130-1206	130-1306		130-2206
	7"	130-1207	130-1307		130-2207
	8"	130-1208	130-1308		130-2208
	9"	130-1209	130-1309		130-2209
	10"	130-1210	130-1310		130-2210
	12"	130-1212	130-1312		130-2212
	14"	130-1214	130-1314		130-2214
	16"		130-1316	(24 gauge)	130-2216
	18"		130-1318		
	20"		130-1320		
	22"		130-1322		
	24"		130-1324		
	26"		130-1326		
	28"				130-1428
	30"				130-1430
	32"				130-1432
	34"				130-1434
		0.025 Aluminum	316 2B Stainless 24 Gauge		
	3"	130-5203	130-2303		
	4"	130-5204	130-2304		
	5"	130-5205	130-2305		
	6"	130-5206	130-2306		
	7"	130-5207	130-2307		
	8"	130-5208	130-2308		
	9"	130-5209	130-2309		
	10"	130-5210	130-2310		
	12"	130-5212	130-2312		
	14"	130-5214	130-2314		

• Riveted construction with uniform crimping at one end.

Yes We Can!

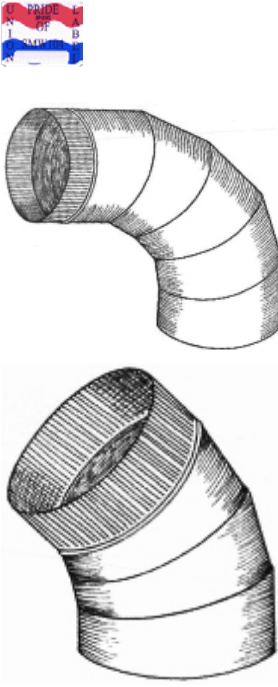
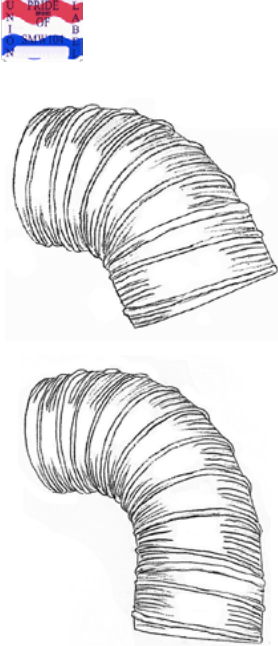

Phone (408) 275-6370
 Fax (408) 881-0177
 sales@acostamfg.com
 www.acostamfg.com

Long Radius Adjustable Elbow	Size	Item #			
		45 Degree	90 Degree		
	<p>24 Gauge</p> <p>4"..... 132-1304..... 133-1304</p> <p>6"..... 132-1306..... 133-1306</p> <p>8"..... 132-1308..... 133-1308</p> <p>10"..... 132-1310..... 133-1310</p> <p>12"..... 132-1312..... 133-1312</p> <p>14"..... 132-1314..... 133-1314</p> <p>16"..... 132-1316..... 133-1316</p> <p>18"..... 132-1318..... 133-1318</p> <p>• Riveted construction with uniform crimping at one end.</p>				
Spiral Elbow	Size	Item #			
		45 Degree Short Radius	90 Degree Short Radius	45 Degree Long Radius	90 Degree Long Radius
	<p>24 Gauge</p> <p>6"..... 152-1206..... 153-1206..... 154-1206..... 155-1206</p> <p>8"..... 152-1208..... 153-1208..... 154-1208..... 155-1208</p> <p>10"..... 152-1210..... 153-1210..... 154-1210..... 155-1210</p> <p>12"..... 152-1212..... 153-1212..... 154-1212..... 155-1212</p> <p>14"..... 152-1214..... 153-1214..... 154-1214..... 155-1214</p> <p>16"..... 152-1316..... 153-1316..... 154-1316..... 155-1316</p> <p>18"..... 152-1318..... 153-1318..... 154-1318..... 155-1318</p> <p>20"..... 152-1320..... 153-1320..... 154-1320..... 155-1320</p> <p>22"..... 152-1322..... 153-1322..... 154-1322..... 155-1322</p> <p>24"..... 152-1324..... 153-1324..... 154-1324..... 155-1324</p>				

Yes We Can!



Phone (408) 275-6370
 Fax (408) 881-0177
 sales@acostamfg.com
 www.acostamfg.com

<p>Spot and Sealed Elbow 90 Degree</p>	<table border="0"> <thead> <tr> <th rowspan="2">Size</th> <th colspan="2">Item #</th> </tr> <tr> <th>Short Radius</th> <th>Long Radius</th> </tr> </thead> <tbody> <tr> <td colspan="3">24 Gauge</td> </tr> <tr> <td>4".....</td> <td>140-1304.....</td> <td>151-1304</td> </tr> <tr> <td>6".....</td> <td>140-1306.....</td> <td>151-1306</td> </tr> <tr> <td>8".....</td> <td>140-1308.....</td> <td>151-1308</td> </tr> <tr> <td>10".....</td> <td>140-1310.....</td> <td>151-1310</td> </tr> <tr> <td>12".....</td> <td>140-1312.....</td> <td>151-1312</td> </tr> <tr> <td>14".....</td> <td>140-1314.....</td> <td>151-1314</td> </tr> <tr> <td>16".....</td> <td>140-1316.....</td> <td>151-1416</td> </tr> <tr> <td>18".....</td> <td>140-1318.....</td> <td>151-1418</td> </tr> <tr> <td>20".....</td> <td>140-1320</td> <td></td> </tr> <tr> <td colspan="3"> <ul style="list-style-type: none"> • Spot-welded construction with uniform Small End/Small End. </td> </tr> </tbody> </table>	Size	Item #		Short Radius	Long Radius	24 Gauge			4".....	140-1304.....	151-1304	6".....	140-1306.....	151-1306	8".....	140-1308.....	151-1308	10".....	140-1310.....	151-1310	12".....	140-1312.....	151-1312	14".....	140-1314.....	151-1314	16".....	140-1316.....	151-1416	18".....	140-1318.....	151-1418	20".....	140-1320		<ul style="list-style-type: none"> • Spot-welded construction with uniform Small End/Small End. 		
Size	Item #																																						
	Short Radius	Long Radius																																					
24 Gauge																																							
4".....	140-1304.....	151-1304																																					
6".....	140-1306.....	151-1306																																					
8".....	140-1308.....	151-1308																																					
10".....	140-1310.....	151-1310																																					
12".....	140-1312.....	151-1312																																					
14".....	140-1314.....	151-1314																																					
16".....	140-1316.....	151-1416																																					
18".....	140-1318.....	151-1418																																					
20".....	140-1320																																						
<ul style="list-style-type: none"> • Spot-welded construction with uniform Small End/Small End. 																																							
<p>Spot and Sealed Elbow 45 Degree</p>	<table border="0"> <thead> <tr> <th rowspan="2">Size</th> <th colspan="2">Item #</th> </tr> <tr> <th>Short Radius</th> <th>Long Radius</th> </tr> </thead> <tbody> <tr> <td colspan="3">24 Gauge</td> </tr> <tr> <td>4".....</td> <td>141-1304.....</td> <td>150-1304</td> </tr> <tr> <td>6".....</td> <td>141-1306.....</td> <td>150-1306</td> </tr> <tr> <td>8".....</td> <td>141-1308.....</td> <td>150-1308</td> </tr> <tr> <td>10".....</td> <td>141-1310.....</td> <td>150-1310</td> </tr> <tr> <td>12".....</td> <td>141-1312.....</td> <td>150-1312</td> </tr> <tr> <td>14".....</td> <td>141-1314.....</td> <td>150-1314</td> </tr> <tr> <td>16".....</td> <td>141-1316.....</td> <td>150-1416</td> </tr> <tr> <td>18".....</td> <td>141-1318.....</td> <td>150-1418</td> </tr> <tr> <td>20".....</td> <td>141-1320</td> <td></td> </tr> <tr> <td colspan="3"> <ul style="list-style-type: none"> • Spot-welded construction with uniform Small End/Small End. </td> </tr> </tbody> </table>	Size	Item #		Short Radius	Long Radius	24 Gauge			4".....	141-1304.....	150-1304	6".....	141-1306.....	150-1306	8".....	141-1308.....	150-1308	10".....	141-1310.....	150-1310	12".....	141-1312.....	150-1312	14".....	141-1314.....	150-1314	16".....	141-1316.....	150-1416	18".....	141-1318.....	150-1418	20".....	141-1320		<ul style="list-style-type: none"> • Spot-welded construction with uniform Small End/Small End. 		
Size	Item #																																						
	Short Radius	Long Radius																																					
24 Gauge																																							
4".....	141-1304.....	150-1304																																					
6".....	141-1306.....	150-1306																																					
8".....	141-1308.....	150-1308																																					
10".....	141-1310.....	150-1310																																					
12".....	141-1312.....	150-1312																																					
14".....	141-1314.....	150-1314																																					
16".....	141-1316.....	150-1416																																					
18".....	141-1318.....	150-1418																																					
20".....	141-1320																																						
<ul style="list-style-type: none"> • Spot-welded construction with uniform Small End/Small End. 																																							
<p>Spot and Sealed Elbow 22.5 Degree</p>	<table border="0"> <thead> <tr> <th rowspan="2">Size</th> <th colspan="2">Item #</th> </tr> <tr> <th colspan="2">Short Radius</th> </tr> </thead> <tbody> <tr> <td colspan="3">24 Gauge</td> </tr> <tr> <td>8".....</td> <td colspan="2">142-1308</td> </tr> <tr> <td>10".....</td> <td colspan="2">142-1310</td> </tr> <tr> <td>12".....</td> <td colspan="2">142-1312</td> </tr> <tr> <td>14".....</td> <td colspan="2">142-1314</td> </tr> <tr> <td>16".....</td> <td colspan="2">142-1316</td> </tr> <tr> <td colspan="3"> <ul style="list-style-type: none"> • Spot-welded construction with uniform Small End/Small End. </td> </tr> </tbody> </table>	Size	Item #		Short Radius		24 Gauge			8".....	142-1308		10".....	142-1310		12".....	142-1312		14".....	142-1314		16".....	142-1316		<ul style="list-style-type: none"> • Spot-welded construction with uniform Small End/Small End. 														
Size	Item #																																						
	Short Radius																																						
24 Gauge																																							
8".....	142-1308																																						
10".....	142-1310																																						
12".....	142-1312																																						
14".....	142-1314																																						
16".....	142-1316																																						
<ul style="list-style-type: none"> • Spot-welded construction with uniform Small End/Small End. 																																							

This page intentionally left blank

WYES&TEES

Wyes and tees for commercial and residential needs







Yes We Can!

Acosta

Sheet Metal Manufacturing, Inc.

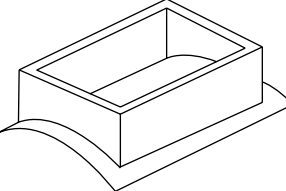

Phone (408) 275-6370
 Fax (408) 881-0177
 sales@acostamfg.com
 www.acostamfg.com

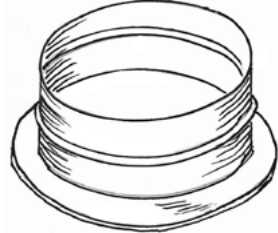
Conical Tap	Size	Item #
 	<p>24 Gauge</p> <p>6".....166-2006</p> <p>8".....166-2008</p> <p>10".....166-2010</p> <p>12".....166-2012</p> <p>14".....166-2014</p> <p>16".....166-2016</p>	
Saddle Tap (Rectangular)	Size	Item #
 	<p>24 Gauge</p> <p>8"x 16" on 10" round.....166-3010</p> <p>8"x 16" on 12" round.....166-3012</p> <p>8"x 16" on 14" round.....166-3014</p> <p>8"x 12" on 10" round.....166-3110</p> <p>8"x 12" on 12" round.....166-3112</p> <p>8"x 12" on 14" round.....166-3114</p>	
Self Stick Collar	Size	Item #
 	<p>26 Gauge</p> <p>4".....180-4104</p> <p>6".....180-4106</p> <p>8".....180-4108</p> <p>10".....180-4110</p> <p>12".....180-4112</p> <p>14".....180-4114</p> <p>24 Gauge</p> <p>16".....180-4116</p> <p>18".....180-4118</p> <p>20".....180-4120</p> <p>22".....180-4122</p> <p>24".....180-4124</p>	





Yes We Can!

Acosta

Sheet Metal Manufacturing, Inc.

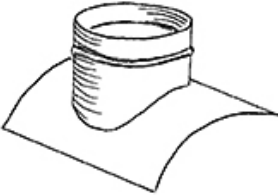

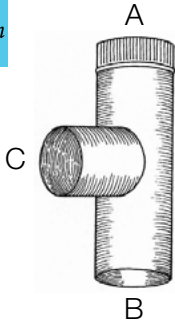
Phone (408) 275-6370
 Fax (408) 881-0177
 sales@acostamfg.com
 www.acostamfg.com

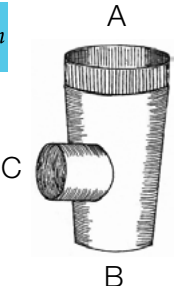
Saddle Tee	Size	Item #
 	24 Gauge	
	6" on 8".....	166-1106
	6" on 10".....	166-1108
	6" on 12".....	166-1110
	8" on 10".....	166-1112
	8" on 12".....	166-1114
	8" on 14".....	166-1116
	10" on 12".....	166-1118
	10" on 14".....	166-1120
	10" on 16".....	166-1122
	12" on 14".....	166-1124
	12" on 16".....	166-1126
	12" on 18".....	166-1128
	14" on 16".....	166-1130
	14" on 18".....	166-1132
	14" on 20".....	166-1134
	• Sealed with DP1010 sealant	
Tee	Size	Item #
 	26 Gauge	
	A x B x C	
	4x4x4".....	165-0010
	6x6x6".....	165-0020
	8x8x8".....	165-0040
10x10x10".....	165-0060	
	• Sealed with DP1010 sealant	
Vent Tee	Size	Item #
 	26 Gauge	
	A x B x C	
	5x4x3".....	165-9010
	6x4x3".....	165-9020
	6x4x4".....	165-9022
	6x5x3".....	165-9025
6x5x4".....	165-9030	
	• Sealed with DP1010 sealant	

Yes We Can!

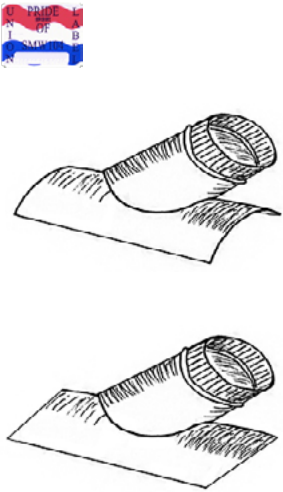
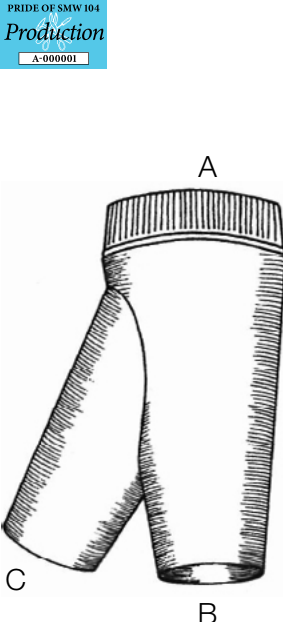

Phone (408) 275-6370
 Fax (408) 881-0177
 sales@acostamfg.com
 www.acostamfg.com

Saddle Wye	Size	Item #
	<p style="text-align: center;"><i>Round</i> <i>Flat</i></p> <p>24 Gauge</p> <p>4" on 6" x 8".....166-1004.....166-1204</p> <p>6" on 8" x 10.....166-1006.....166-1206</p> <p>8" on 10" x 12".....166-1008.....166-1208</p> <p>10" on 12" x 14".....166-1010.....166-1210</p> <p>12" on 14" x 16".....166-1012.....166-1212</p> <p>14" on 16" x 18".....166-1014</p> <p>• Sealed with DP1010 sealant</p>	
Vent Wye	Size	Item #
	<p>26 Gauge</p> <p>A x B x C</p> <p>5x4x3".....160-9020</p> <p>5x4x4".....160-9025</p> <p>6x4x3".....160-9030</p> <p>6x5x3".....160-9035</p> <p>6x5x4".....160-9040</p> <p>• Sealed with DP1010 sealant</p>	

Phone (408) 275-6370
 Fax (408) 881-0177
 sales@acostamfg.com
 www.acostamfg.com

Yes We Can!



Stock Wye Branches	Size	Item #	Item #	
<div data-bbox="110 499 212 569" style="border: 1px solid black; padding: 2px;"> PRIDE OF SMW 104 Production A-000001 </div> <div data-bbox="138 945 373 1323" style="text-align: center;"> </div>	A x B x C 26 Gauge	A x B x C 26 Gauge		
	6x4x4.....	160-0105	14x12x10.....	160-0535
	6x6x4.....	160-0110	14x12x12.....	160-0540
	8x6x4.....	160-0205	14x14x6.....	160-0545
	8x6x6.....	160-0210	14x14x8.....	160-0550
	8x8x4.....	160-0215	14x14x10.....	160-0555
	8x8x6.....	160-0220	14x14x12.....	160-0560
	10x6x6.....	160-0305	14x14x14.....	160-0565
	10x8x4.....	160-0310		
	10x8x6.....	160-0315	24 Gauge	
	10x8x8.....	160-0320	16x12x10.....	160-0620
	10x10x4.....	160-0325	16x12x12.....	160-0625
	10x10x6.....	160-0330	16x14x8.....	160-0630
	10x10x8.....	160-0335	16x14x10.....	160-0635
	4x4x4.....	160-0005	16x14x12.....	160-0640
	6x6x6.....	160-0115	16x14x14.....	160-0645
	8x8x8.....	160-0225	16x16x8.....	160-0615
	10x10x10.....	160-0340	16x16x12.....	160-0650
	12x12x10.....	160-0450	16x16x14.....	160-0655
	12x12x12.....	160-0455	18x14x12.....	160-0720
	12x8x8.....	160-0410	18x14x14.....	160-0725
	12x10x4.....	160-0415	18x16x10.....	160-0730
	12x10x6.....	160-0420	18x16x12.....	160-0735
	12x10x8.....	160-0425	18x16x14.....	160-0740
	12x10x10.....	160-0430	18x16x16.....	160-0741
	12x12x4.....	160-0435	20x14x14.....	160-0830
	12x12x6.....	160-0440	20x16x14.....	160-0835
	12x12x8.....	160-0445	20x16x16.....	160-0840
	14x10x8.....	160-0515	20x18x14.....	160-0845
	14x10x10.....	160-0520	20x18x16.....	160-0850
	14x12x6.....	160-0525		
	14x12x8.....	160-0530		

• Sealed with DP1010 sealant

This page intentionally left blank

HVAC FITTINGS & ACCESSORIES

Fittings and pipe accessories for commercial and residential needs



Yes We Can!

Acosta

Sheet Metal Manufacturing, Inc.



Phone (408) 275-6370
 Fax (408) 881-0177
 sales@acostamfg.com
 www.acostamfg.com

Ceiling Box	Size	Item #
<div data-bbox="113 504 219 577" style="border: 1px solid black; padding: 2px;"> PRIDE OF SMW 104 Production A-000001 </div> <div data-bbox="129 829 373 1050"> </div> <div data-bbox="129 1134 373 1344"> </div>	A x B x C 28 Gauge	
	4x8x4"	215-0504
	4x10x4"	215-0514
	6x6x6"	215-1016
	6x10x6"	215-0526
	6x12x6"	215-0536
	6x12x8"	215-0538
	6x14x6"	215-0546
	6x14x8"	215-0548
	8x8x6"	215-1026
	8x8x8"	215-1028
	8x10x8"	215-0558
	8x12x8"	215-0568
	8x14x8"	215-0578
	10x10x8"	215-1038
	10x10x10"	215-1030
	12x12x10"	215-1040
	12x12x12"	215-1042
	14x14x12"	215-1052
	14x14x14"	215-1054
	16x16x14"	215-1064
	26 Gauge	
	14.25x20.25x12"	215-1522
	14.25x20.25x14"	215-1524
	14.25x24.25x12"	215-1532
	14.25x24.25x14"	215-1534
	14.25x24.25x16"	215-1536
	14.25x25.25x14"	215-1544
	14.25x25.25x16"	215-1546
	24 Gauge	
18x18x16"	215-1610	
20x20x18"	215-1620	
22x22x20"	215-1630	
<ul style="list-style-type: none"> Sealed with DP1010 Sealant 		

Yes We Can!

Acosta

Sheet Metal Manufacturing, Inc.

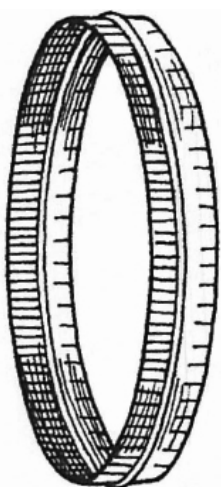
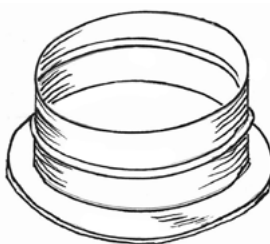

Phone (408) 275-6370
 Fax (408) 881-0177
 sales@acostamfg.com
 www.acostamfg.com

Collar	Size	Item #			
 <p>PRIDE OF SMW 104 Production A-000001</p>		<i>DT/Raw</i>	<i>DT/Crimp</i>	<i>Spin/Raw</i>	<i>Spin/Crimp</i>
	4".....	180-1204.....	180-1304.....	180-1404.....	180-1504
	5".....	180-1205.....	180-1305.....	180-1405.....	180-1505
	6".....	180-1206.....	180-1306.....	180-1406.....	180-1506
	7".....	180-1207.....	180-1307.....	180-1407.....	180-1507
	8".....	180-1208.....	180-1308.....	180-1408.....	180-1508
	10".....	180-1210.....	180-1310.....	180-1410.....	180-1510
	12".....	180-1212.....	180-1312.....	180-1412.....	180-1512
	14".....	180-1214.....	180-1314.....	180-1414.....	180-1514
	16".....	180-1216.....	180-1316.....	180-1416.....	180-1516
	18".....	180-1218.....	180-1318.....	180-1418.....	180-1518
	20".....	180-1220.....	180-1320.....	180-1420.....	180-1520
	22".....	180-1222.....	180-1322.....	180-1422.....	180-1522
	24".....	180-1224.....	180-1324.....	180-1424.....	180-1524
Self Stick Collar	Size	Item #			
 <p>PRIDE OF SMW 104 Production A-000001</p>		<i>26 Gauge</i>			
	4".....	180-4104			
	6".....	180-4106			
	8".....	180-4108			
	10".....	180-4110			
	12".....	180-4112			
		<i>24 Gauge</i>			
	14".....	180-4114			
	16".....	180-4116			
	18".....	180-4118			
	20".....	180-4120			
	22".....	180-4122			
	24".....	180-4124			





Yes We Can!

Acosta

Sheet Metal Manufacturing, Inc.



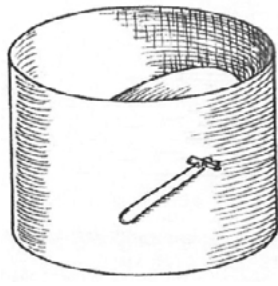

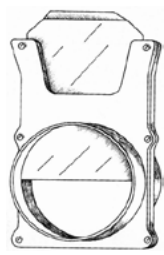

Phone (408) 275-6370
 Fax (408) 881-0177
 sales@acostamfg.com
 www.acostamfg.com

Collar with Damper	Size	Item #		
		<i>"Jiffy" Hardware</i>	<i>Heavy-duty Hardware</i>	
  	4"	180-4004		
	5"	180-4005		
	6"	180-4006	180-3906	
	7"	180-4007		
	8"	180-4008	180-3908	
	9"	180-4009		
	10"	180-4010	180-3910	
	12"	180-4012	180-3912	
	14"	180-4014	180-3914	
	16"	180-4016	180-3916	
	18"	180-4018	180-3918	
		Size	Item #	
			<i>Galvanized Blade</i>	<i>Stainless Steel Blade</i>
		<i>26 Gauge</i>		
4"		175-0104	175-0204	
5"		175-0105		
6"		175-0106	175-0206	
7"		175-0107		
8"		175-0108	175-0208	
9"		175-0109		
<i>24 Gauge</i>				
10"		175-0110		
12"		175-0112		
14"		175-0114		
16"		175-0116		
18"	175-0118			
20"	175-0120			
Blast Gate Damper	Size	Item #		
		<i>Galvanized Blade</i>	<i>Stainless Steel Blade</i>	
	2"	175-2002		
	3"	175-2003		
	4"	175-2004	175-2104	
	5"	175-2005		
	6"	175-2006	175-2106	
	8"	175-2008	175-2108	

Phone (408) 275-6370
 Fax (408) 881-0177
 sales@acostamfg.com
 www.acostamfg.com

Yes We Can!

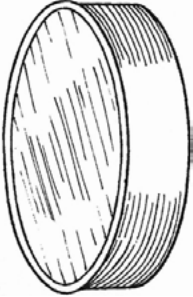
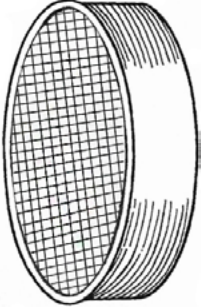

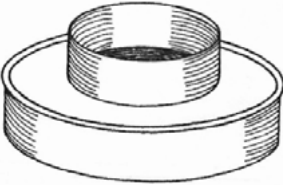

End Cap (Round)	Size	Item #
   	<i>Galvanized</i>	<i>304 2B Stainless Steel</i>
	<i>With 0.25" Mesh</i>	
	<i>26 Gauge</i>	
	3".....	185-1003
	4".....	185-1004.....185-2204
	5".....	185-1005
	6".....	185-1006.....185-2206.....185-1206
	7".....	185-1007
	8".....	185-1008.....185-2208.....185-1208
	9".....	185-1009
	10".....	185-1010.....185-1210
	12".....	185-1012.....185-1212
	14".....	185-1014.....185-1214
	<i>24 Gauge</i>	
	16".....	185-1016
	18".....	185-1018
	20".....	185-1020
	22".....	185-1022
	24".....	185-1024
Reducer	Size	Item #
 	4x3".....	190-3005
	5x3".....	190-3013
	5x4".....	190-3014
	6x3".....	190-3023
	6x4".....	190-3024
	6x5".....	190-3025
	7x6".....	190-3036
	8x6".....	190-3046
	10x8".....	190-3058
	12x8".....	190-3068
	12x10".....	190-3060
	14x12".....	190-3072
	16x14".....	190-3084
	18x16".....	190-3096

Yes We Can!



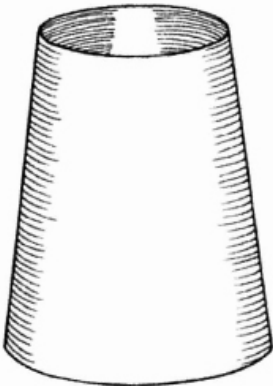

Phone (408) 275-6370
 Fax (408) 881-0177
 sales@acostamfg.com
 www.acostamfg.com

Taper	Size	Item #
 	4-3".....	190-1005
	5-3".....	190-1013
	5-4".....	190-1014
	6-3".....	190-1023
	6-4".....	190-1024
	6-5".....	190-1025
	7"-6".....	190-1036
	8-4".....	190-1044
	8-6".....	190-1046
	8-7".....	190-1047
	10-6".....	190-1056
	10-8".....	190-1058
	10-9".....	190-1059
	12-10".....	190-1060
	12-8".....	190-1068
	14-10".....	190-1070
	14-12".....	190-1072
16-14".....	190-1084	
Taper with Collar	Size	Item #
 	24 Gauge	
	8-6".....	190-2046
	10-8".....	190-2058
	12-10".....	190-2060
	14-10".....	190-2068
	14-12".....	190-2072
	16-14".....	190-2084
	18-16".....	190-2066

Yes We Can!

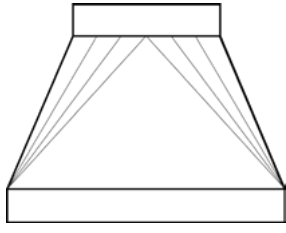

Phone (408) 275-6370
 Fax (408) 881-0177
 sales@acostamfg.com
 www.acostamfg.com

Taper with Collar (for Spiral)	Size	Item #
 	<i>24 Gauge</i>	
	6-4"	190-2144
	8-4"	190-2147
	8-6"	190-2146
	10-6"	190-2159
	10-8"	190-2158
	12-8"	190-2161
	12-10"	190-2160
	14-10"	190-2173
	14-12"	190-2172
	16-12"	190-2186
	16-14"	190-2184
	18-14"	190-2167
	18-16"	190-2166
	20-16"	190-2169
	20-18"	190-2168
	22-18"	190-2196
	22-20"	190-2194
	24-20"	190-2192
	24-22"	190-2190
Square to Round	Size	Item #
 	<i>24 Gauge</i>	
	10x12" to 8" round.....	168-1200
	10x12" to 10" round.....	168-1210
	10x12" to 12" round.....	168-1220
	10x12" to 14" round.....	168-1230
	12x14" to 8" round.....	168-1400
	12x14" to 10" round.....	168-1410
	12.5x14" to 12" round.....	168-1600
	12.5x14" to 14" round.....	168-1800
	15x16" to 16" round.....	168-2000
	15x16" to 18" round.....	168-2200
	20x17.5" to 16" round.....	168-2400
20x17.5" to 18" round.....	168-2600	

Yes We Can!

Acosta

Sheet Metal Manufacturing, Inc.

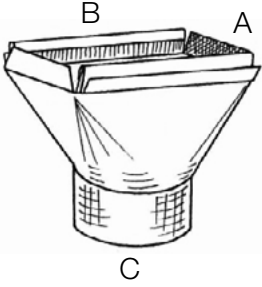
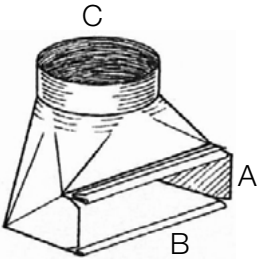
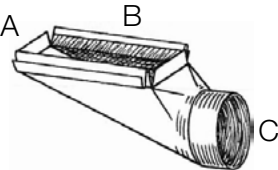

Phone (408) 275-6370
 Fax (408) 881-0177
 sales@acostamfg.com
 www.acostamfg.com

F-5 Straight Boot	Size	Item #
<p>PRIDE OF SMW 104 Production A-000001</p> 	<p>A x B x C 3.25x10x4".....210-5014 3.25x10x6".....210-5016 3.25x10x7".....210-5017 3.25x10x8".....210-5018 3.25x12x6".....210-5026 3.25x12x8".....210-5028 3.25x14x6".....210-5036 3.25x14x8".....210-5038</p> <ul style="list-style-type: none"> Sealed with DP1010 Sealant 	
F-13 Angle Boot 90 Degree	Size	Item #
<p>PRIDE OF SMW 104 Production A-000001</p> 	<p>A x B x C 3.25x10x4".....210-6014 3.25x10x6".....210-6016 3.25x10x8".....210-6018 3.25x12x6".....210-6026 3.25x12x8".....210-6028 3.25x14x6".....210-6036 3.25x14x8".....210-6038</p> <ul style="list-style-type: none"> Sealed with DP1010 Sealant 	
F-17 Cone Boot	Size	Item #
<p>PRIDE OF SMW 104 Production A-000001</p> 	<p>A x B x C 3.25x10x6".....210-7016 3.25x10x8".....210-7018 3.25x12x6".....210-7026 3.25x12x8".....210-7028 3.25x14x6".....210-7036 3.25x14x8".....210-7038</p> <ul style="list-style-type: none"> Sealed with DP1010 Sealant 	

Yes We Can!

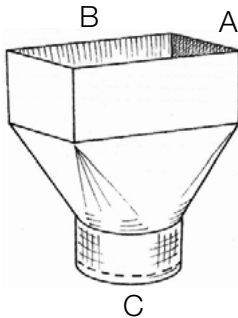
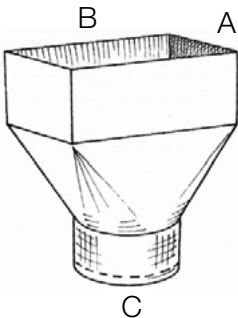

Phone (408) 275-6370
 Fax (408) 881-0177
 sales@acostamfg.com
 www.acostamfg.com

Fan Boot	Size	Item #
<p>PRIDE OF SMW 104 Production A-000001</p> 	<p>A x B x C 3.25x10x6"210-5116 3.25x10x7"210-5117</p> <p>• Sealed with DP1010 Sealant</p>	
PH 1	Size	Item #
<p>PRIDE OF SMW 104 Production A-000001</p> 	<p>A x B x C 2.25x10x4"200-1100 2.25x10x6"200-1102 2.25x12x6"200-1105 2.25x14x6"200-1112 2.25x14x8"200-1114 4x10x4"200-1120 4x10x6"200-1122 4x12x6"200-1132 4x12x8"200-1134 4x14x6"200-1142 4x14x8"200-1144 6x10x6"200-1152 6x12x6"200-1162 6x12x8"200-1164 6x14x8"200-1174</p> <p>• Sealed with DP1010 Sealant</p>	

Yes We Can!

Acosta

Sheet Metal Manufacturing, Inc.

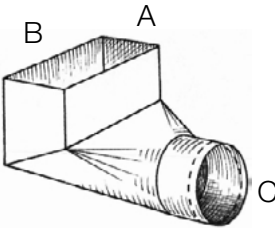
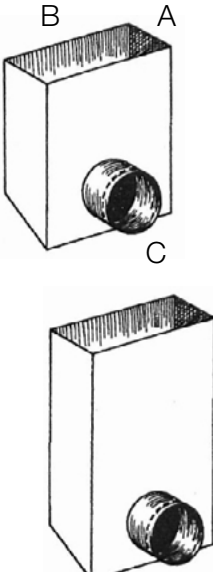

Phone (408) 275-6370
 Fax (408) 881-0177
 sales@acostamfg.com
 www.acostamfg.com

PH 2	Size	Item #
 <p>PRIDE OF SMW 104 Production A-000001</p>	<p>A x B x C</p> <p>2.25x10x4".....200-1200</p> <p>2.25x10x6".....200-1202</p> <p>2.25x12x6".....200-1205</p> <p>2.25x14x6".....200-1212</p> <p>4x10x4".....200-1220</p> <p>4x10x6".....200-1222</p> <p>4x12x6".....200-1232</p> <p>4x12x8".....200-1234</p> <p>4x14x6".....200-1242</p> <p>4x14x8".....200-1244</p> <p>6x10x6".....200-1252</p> <p>6x12x6".....200-1262</p> <p>6x12x8".....200-1264</p> <p>6x14x8".....200-1274</p> <p>8x14x8".....200-1284</p> <p>• Sealed with DP1010 Sealant</p>	
PH 2A	Size	
 <p>PRIDE OF SMW 104 Production A-000001</p>	<p>A x B x C</p> <p>4x10x4".....200-2100</p> <p>4x12x6".....200-2103</p> <p>4x14x6".....200-2042.....200-2142</p> <p>4x14x8".....200-2044.....200-2144</p> <p>6x12x6".....200-2062.....200-2154</p> <p>6x12x8".....200-2160</p> <p>6x14x8".....200-2074.....200-2174</p> <p>8x12x8".....200-2194</p> <p>8x14x8".....200-2084.....200-2184</p> <p>• Sealed with DP1010 Sealant</p>	<p>16" Long</p> <p>24" Long</p>

Yes We Can!

Acosta

Sheet Metal Manufacturing, Inc.

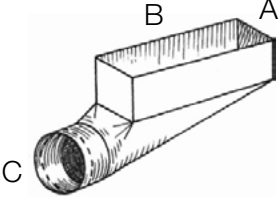
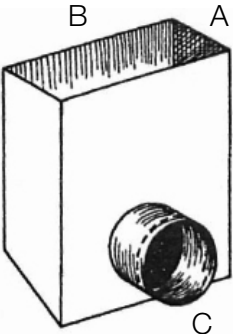

Phone (408) 275-6370
 Fax (408) 881-0177
 sales@acostamfg.com
 www.acostamfg.com

PH 3	Size	Item #
<div data-bbox="110 510 212 575" style="border: 1px solid black; padding: 2px;"> PRIDE OF SMW 104 Production A-000001 </div> 	<p>A x B x C</p> <p>2.25x10x4".....200-1300</p> <p>2.25x12x6".....200-1305</p> <p>2.25x14x6".....200-1312</p> <p>4x10x4".....200-1320</p> <p>4x10x6".....200-1322</p> <p>4x12x6".....200-1332</p> <p>4x12x8".....200-1334</p> <p>4x14x6".....200-1342</p> <p>4x14x8".....200-1344</p> <p>6x10x6".....200-1352</p> <p>6x12x6".....200-1362</p> <p>6x12x8".....200-1364</p> <p>6x14x8".....200-1374</p> <p>• Sealed with DP1010 Sealant</p>	
Perimeter Box	Size	Item #
<div data-bbox="110 1337 212 1402" style="border: 1px solid black; padding: 2px;"> PRIDE OF SMW 104 Production A-000001 </div> 	<p>A x B x C</p> <p>2.25x14x6".....200-3012</p> <p>2.25x14x8".....200-3014</p> <p>4x10x4".....200-3020</p> <p>4x10x6".....200-3022</p> <p>4x12x6".....200-3032</p> <p>4x12x8".....200-3034</p> <p>4x14x6".....200-3042</p> <p>4x14x8".....200-3044</p> <p>6x10x6".....200-3052</p> <p>• Sealed with DP1010 Sealant</p>	





Yes We Can!

Acosta

Sheet Metal Manufacturing, Inc.

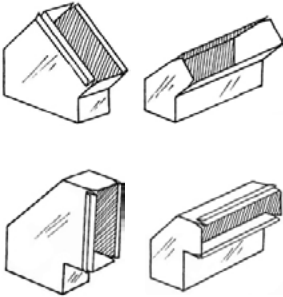

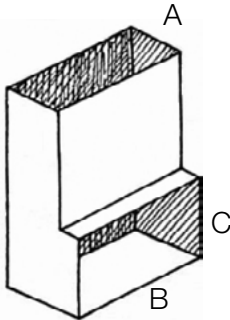
Phone (408) 275-6370
 Fax (408) 881-0177
 sales@acostamfg.com
 www.acostamfg.com

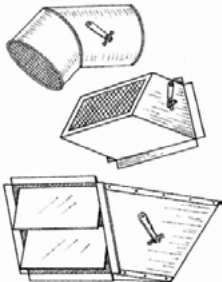
Riser Elbow	Size	Item #																							
 	<table border="0"> <thead> <tr> <th></th> <th><i>90 Degree Long Way</i></th> <th><i>90 Degree Short Way</i></th> <th><i>45 Degree Long Way</i></th> <th><i>45 Degree Short Way</i></th> </tr> </thead> <tbody> <tr> <td>3.25x10".....</td> <td>210-3110.....</td> <td>210-3010.....</td> <td>210-2110.....</td> <td>210-2010.....</td> </tr> <tr> <td>3.25x12".....</td> <td>210-3112.....</td> <td>210-3012.....</td> <td>210-2112.....</td> <td>210-2012.....</td> </tr> <tr> <td>3.25x14".....</td> <td>210-3114.....</td> <td>210-3014.....</td> <td>210-2114.....</td> <td>210-2014.....</td> </tr> </tbody> </table>		<i>90 Degree Long Way</i>	<i>90 Degree Short Way</i>	<i>45 Degree Long Way</i>	<i>45 Degree Short Way</i>	3.25x10".....	210-3110.....	210-3010.....	210-2110.....	210-2010.....	3.25x12".....	210-3112.....	210-3012.....	210-2112.....	210-2012.....	3.25x14".....	210-3114.....	210-3014.....	210-2114.....	210-2014.....				
	<i>90 Degree Long Way</i>	<i>90 Degree Short Way</i>	<i>45 Degree Long Way</i>	<i>45 Degree Short Way</i>																					
3.25x10".....	210-3110.....	210-3010.....	210-2110.....	210-2010.....																					
3.25x12".....	210-3112.....	210-3012.....	210-2112.....	210-2012.....																					
3.25x14".....	210-3114.....	210-3014.....	210-2114.....	210-2014.....																					
 	<table border="0"> <thead> <tr> <th>Size</th> <th>Item #</th> </tr> </thead> <tbody> <tr> <td>A x B x C</td> <td></td> </tr> <tr> <td>3.25x10x4".....</td> <td>210-4014</td> </tr> <tr> <td>3.25x10x6".....</td> <td>210-4016</td> </tr> <tr> <td>3.25x12x4".....</td> <td>210-4024</td> </tr> <tr> <td>3.25x12x6".....</td> <td>210-4026</td> </tr> <tr> <td>3.25x14x4".....</td> <td>210-4034</td> </tr> <tr> <td>3.25x14x6".....</td> <td>210-4036</td> </tr> <tr> <td>3.25x14x8".....</td> <td>210-4038</td> </tr> </tbody> </table>	Size	Item #	A x B x C		3.25x10x4".....	210-4014	3.25x10x6".....	210-4016	3.25x12x4".....	210-4024	3.25x12x6".....	210-4026	3.25x14x4".....	210-4034	3.25x14x6".....	210-4036	3.25x14x8".....	210-4038						
Size	Item #																								
A x B x C																									
3.25x10x4".....	210-4014																								
3.25x10x6".....	210-4016																								
3.25x12x4".....	210-4024																								
3.25x12x6".....	210-4026																								
3.25x14x4".....	210-4034																								
3.25x14x6".....	210-4036																								
3.25x14x8".....	210-4038																								
 	<table border="0"> <thead> <tr> <th>Size</th> <th colspan="2">Item #</th> </tr> <tr> <td></td> <th><i>With Screen and Damper</i></th> <th><i>With Screen and Backdraft Damper</i></th> </tr> </thead> <tbody> <tr> <td><i>Round</i></td> <td></td> <td></td> </tr> <tr> <td>6".....</td> <td>504-0506</td> <td></td> </tr> <tr> <td>8".....</td> <td>504-0508</td> <td></td> </tr> <tr> <td><i>Square</i></td> <td></td> <td></td> </tr> <tr> <td>8"x8".....</td> <td>504-1505.....</td> <td>504-2005</td> </tr> <tr> <td>8"x16".....</td> <td>504-1510.....</td> <td>504-2010</td> </tr> </tbody> </table>	Size	Item #			<i>With Screen and Damper</i>	<i>With Screen and Backdraft Damper</i>	<i>Round</i>			6".....	504-0506		8".....	504-0508		<i>Square</i>			8"x8".....	504-1505.....	504-2005	8"x16".....	504-1510.....	504-2010
Size	Item #																								
	<i>With Screen and Damper</i>	<i>With Screen and Backdraft Damper</i>																							
<i>Round</i>																									
6".....	504-0506																								
8".....	504-0508																								
<i>Square</i>																									
8"x8".....	504-1505.....	504-2005																							
8"x16".....	504-1510.....	504-2010																							

Yes We Can!

Acosta

Sheet Metal Manufacturing, Inc.





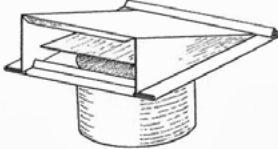
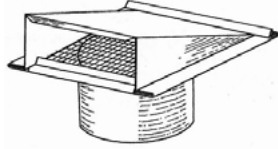
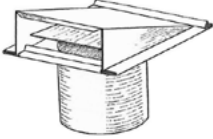
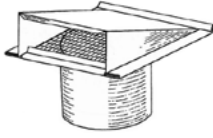
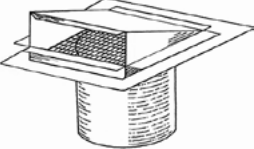
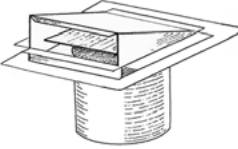



Phone (408) 275-6370
 Fax (408) 881-0177
 sales@acostamfg.com
 www.acostamfg.com

"Old Style" Rain Hood	Size	Item #	
 		<i>With Screen</i>	<i>With Backdraft Damper</i>
	3".....	502-0503.....	502-1003
	4".....	502-0504.....	502-1004
	5".....	502-0505.....	502-1005
	6".....	502-0506.....	502-1006
	7".....	502-0507.....	502-1007
	8".....	502-0508	
	10".....	502-0510	
	3.25"x10" Square		
	(Screen Only).....	502-1505	
Rain Hood (for wood)	Size	Item #	
 		<i>With Screen</i>	<i>With Backdraft Damper</i>
	4".....	503-0604.....	503-1104
	6".....	503-0606.....	503-1106
	8".....	503-0608.....	503-1108
Rain Hood (for stucco)	Size	Item #	
 		<i>With Screen</i>	<i>With Backdraft Damper</i>
	4".....	503-0504.....	503-1004
	6".....	503-0506.....	503-1006
	8".....	503-0508.....	503-1008

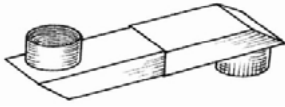
Yes We Can!

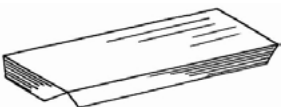

Phone (408) 275-6370
 Fax (408) 881-0177
 sales@acostamfg.com
 www.acostamfg.com

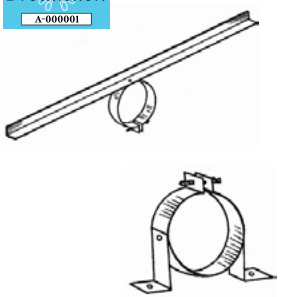
Dryer Vent	Size	Item #		
 	4.....	200-7000		
Dust Cover	Size	Item #		
 	4x10".....	200-3230		
	4x12".....	200-3235		
	4x14".....	200-3240		
	6x10".....	200-3245		
	6x12".....	200-3250		
	6x14".....	200-3255		
Perimeter Cover	Size	Item #		
 	2.25x10".....	200-3100	4x10".....	200-3130
	2.25x12".....	200-3105	4x12".....	200-3135
	2.25x14".....	200-3110	4x14".....	200-3140
	3.25x10".....	200-3115	6x10".....	200-3145
	3.25x12".....	200-3120	6x12".....	200-3150
	3.25x14".....	200-3125	6x14".....	200-3155
Flue Bracket	Size	Item #		
 		<i>With Legs</i>	<i>With Bar</i>	
	3".....	382-1023.....	382-1003	
	4".....	382-1024.....	382-1004	
	5".....	382-1025.....	382-1005	
	6".....	382-1026.....	382-1006	
	7".....	382-1027.....	382-1007	
	8".....	382-1028.....	382-1008	

GUTTER&ROOFING









Gutter and roofing materials for commercial and residential needs

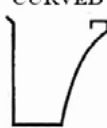

Yes We Can!



Phone (408) 275-6370
 Fax (408) 881-0177
 sales@acostamfg.com
 www.acostamfg.com

Gutter	Size	Item #																																																																																																					
<div data-bbox="110 499 219 573" style="border: 1px solid black; padding: 2px;"> PRIDE OF SMW 104 Production A-000001 </div> <div style="display: flex; justify-content: space-around; margin-top: 10px;"> <div style="text-align: center;"> <p>OG STYLE</p>  </div> <div style="text-align: center;"> <p>PLAIN</p>  </div> </div> <div style="text-align: center; margin-top: 10px;"> <p>CURVED</p>  </div> <div style="display: flex; justify-content: space-around; margin-top: 10px;"> <div style="text-align: center;"> <p>TILE</p>  </div> <div style="text-align: center;"> <p>DECCO</p>  </div> </div>	<table border="0" style="width: 100%; border-collapse: collapse;"> <thead> <tr> <th style="width: 10%;"></th> <th style="width: 15%;"></th> <th style="width: 20%; text-align: center;"><i>OG Style</i></th> <th style="width: 20%; text-align: center;"><i>Plain</i></th> <th style="width: 20%; text-align: center;"><i>Curved</i></th> <th style="width: 25%; text-align: center;"><i>Decco</i></th> <th style="width: 20%; text-align: center;"><i>Tile/Decco</i></th> </tr> </thead> <tbody> <tr> <td rowspan="3">4"</td> <td>20'.....</td> <td>700-0620</td> <td></td> <td></td> <td></td> <td></td> </tr> <tr> <td>25'.....</td> <td>700-0625</td> <td></td> <td></td> <td></td> <td></td> </tr> <tr> <td>30'.....</td> <td>700-0630</td> <td></td> <td></td> <td></td> <td></td> </tr> <tr> <td rowspan="3">5"</td> <td>20'.....</td> <td>700-1120</td> <td></td> <td></td> <td></td> <td></td> </tr> <tr> <td>25'.....</td> <td>700-1125</td> <td></td> <td></td> <td></td> <td></td> </tr> <tr> <td>30'.....</td> <td>700-1130</td> <td></td> <td></td> <td></td> <td></td> </tr> <tr> <td rowspan="3">5.25"</td> <td>20'.....</td> <td>701-0620</td> <td>701-1120</td> <td>701-1620</td> <td></td> <td></td> </tr> <tr> <td>25'.....</td> <td>701-0625</td> <td>701-1125</td> <td>701-1625</td> <td></td> <td></td> </tr> <tr> <td>30'.....</td> <td>701-0630</td> <td>701-1130</td> <td>701-1630</td> <td></td> <td></td> </tr> <tr> <td rowspan="3">6"</td> <td>20'.....</td> <td>700-1620</td> <td></td> <td></td> <td></td> <td></td> </tr> <tr> <td>25'.....</td> <td>700-1625</td> <td></td> <td></td> <td></td> <td></td> </tr> <tr> <td>30'.....</td> <td>700-1630</td> <td></td> <td></td> <td></td> <td></td> </tr> <tr> <td rowspan="3">7.25"</td> <td>20'.....</td> <td>702-0620</td> <td></td> <td>702-1620</td> <td></td> <td></td> </tr> <tr> <td>25'.....</td> <td>702-0625</td> <td>702-1125</td> <td>702-1625</td> <td>703-1625</td> <td></td> </tr> <tr> <td>30'.....</td> <td>702-0630</td> <td>702-1130</td> <td>702-1630</td> <td>703-1630</td> <td></td> </tr> </tbody> </table>			<i>OG Style</i>	<i>Plain</i>	<i>Curved</i>	<i>Decco</i>	<i>Tile/Decco</i>	4"	20'.....	700-0620					25'.....	700-0625					30'.....	700-0630					5"	20'.....	700-1120					25'.....	700-1125					30'.....	700-1130					5.25"	20'.....	701-0620	701-1120	701-1620			25'.....	701-0625	701-1125	701-1625			30'.....	701-0630	701-1130	701-1630			6"	20'.....	700-1620					25'.....	700-1625					30'.....	700-1630					7.25"	20'.....	702-0620		702-1620			25'.....	702-0625	702-1125	702-1625	703-1625		30'.....	702-0630	702-1130	702-1630	703-1630	
		<i>OG Style</i>	<i>Plain</i>	<i>Curved</i>	<i>Decco</i>	<i>Tile/Decco</i>																																																																																																	
4"	20'.....	700-0620																																																																																																					
	25'.....	700-0625																																																																																																					
	30'.....	700-0630																																																																																																					
5"	20'.....	700-1120																																																																																																					
	25'.....	700-1125																																																																																																					
	30'.....	700-1130																																																																																																					
5.25"	20'.....	701-0620	701-1120	701-1620																																																																																																			
	25'.....	701-0625	701-1125	701-1625																																																																																																			
	30'.....	701-0630	701-1130	701-1630																																																																																																			
6"	20'.....	700-1620																																																																																																					
	25'.....	700-1625																																																																																																					
	30'.....	700-1630																																																																																																					
7.25"	20'.....	702-0620		702-1620																																																																																																			
	25'.....	702-0625	702-1125	702-1625	703-1625																																																																																																		
	30'.....	702-0630	702-1130	702-1630	703-1630																																																																																																		
<div data-bbox="110 1350 219 1423" style="border: 1px solid black; padding: 2px;"> PRIDE OF SMW 104 Production A-000001 </div> <div style="display: flex; justify-content: space-around; margin-top: 10px;"> <div style="text-align: center;">  </div> <div style="text-align: center;">  </div> </div> <div style="display: flex; justify-content: space-around; margin-top: 10px;"> <div style="text-align: center;">  </div> <div style="text-align: center;">  </div> </div>	<table border="0" style="width: 100%; border-collapse: collapse;"> <thead> <tr> <th style="width: 10%;"></th> <th style="width: 15%;"></th> <th style="width: 20%; text-align: center;"><i>OG Style</i></th> <th style="width: 20%; text-align: center;"><i>Plain</i></th> <th style="width: 20%; text-align: center;"><i>Curved</i></th> <th style="width: 25%; text-align: center;"><i>Decco/Tile</i></th> </tr> </thead> <tbody> <tr> <td rowspan="2">4"</td> <td>Left.....</td> <td>709-0505</td> <td></td> <td></td> <td></td> </tr> <tr> <td>Right.....</td> <td>709-0506</td> <td></td> <td></td> <td></td> </tr> <tr> <td rowspan="2">5"</td> <td>Left.....</td> <td>709-0510</td> <td></td> <td></td> <td></td> </tr> <tr> <td>Right.....</td> <td>709-0511</td> <td></td> <td></td> <td></td> </tr> <tr> <td rowspan="2">5.25"</td> <td>Left.....</td> <td>709-0520</td> <td>709-0525</td> <td></td> <td></td> </tr> <tr> <td>Right.....</td> <td>709-0521</td> <td>709-0526</td> <td></td> <td></td> </tr> <tr> <td rowspan="2">6"</td> <td>Left.....</td> <td>709-0515</td> <td></td> <td></td> <td></td> </tr> <tr> <td>Right.....</td> <td>709-0516</td> <td></td> <td></td> <td></td> </tr> <tr> <td rowspan="2">7.25"</td> <td>Left.....</td> <td>709-0530</td> <td>709-0535</td> <td>709-0540</td> <td></td> </tr> <tr> <td>Right.....</td> <td>709-0531</td> <td>709-0536</td> <td>709-0541</td> <td></td> </tr> </tbody> </table>			<i>OG Style</i>	<i>Plain</i>	<i>Curved</i>	<i>Decco/Tile</i>	4"	Left.....	709-0505				Right.....	709-0506				5"	Left.....	709-0510				Right.....	709-0511				5.25"	Left.....	709-0520	709-0525			Right.....	709-0521	709-0526			6"	Left.....	709-0515				Right.....	709-0516				7.25"	Left.....	709-0530	709-0535	709-0540		Right.....	709-0531	709-0536	709-0541																																										
		<i>OG Style</i>	<i>Plain</i>	<i>Curved</i>	<i>Decco/Tile</i>																																																																																																		
4"	Left.....	709-0505																																																																																																					
	Right.....	709-0506																																																																																																					
5"	Left.....	709-0510																																																																																																					
	Right.....	709-0511																																																																																																					
5.25"	Left.....	709-0520	709-0525																																																																																																				
	Right.....	709-0521	709-0526																																																																																																				
6"	Left.....	709-0515																																																																																																					
	Right.....	709-0516																																																																																																					
7.25"	Left.....	709-0530	709-0535	709-0540																																																																																																			
	Right.....	709-0531	709-0536	709-0541																																																																																																			

Yes We Can!





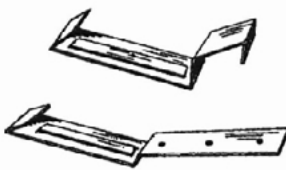
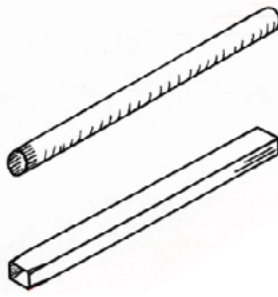

Phone (408) 275-6370
 Fax (408) 881-0177
 sales@acostamfg.com
 www.acostamfg.com

Gutter Strap	Size	Item #	
		<i>Hook</i>	<i>Nail</i>
	4" OG.....	709-1106.....	709-1006
	5" OG.....	709-1110.....	709-1010
	5.25".....	709-1105.....	709-1005
	6" OG.....	709-1115.....	709-1015
	7.25".....	709-1120.....	709-1020
	7.25" Tile.....		709-1025
Leader/Conductor Pipe	Size	Item #	
	<i>26 gauge Galvanized</i>		
	1.75"x 2.75".....	710-0510	
	2"x 3".....	710-1010	
	3"x 4".....	710-1510	
	2".....	712-0502	
	3".....	712-0503	
	4".....	712-0504	
	5".....	712-0505	
	6".....	712-0506	
	<i>26 gauge Bonderized</i>		
	1.75"x 2.75" 10'.....	710-0610	
	11'.....	710-0611	
	12'.....	710-0612	
	14'.....	710-0614	
	20'.....	710-0620	
2"x 3".....	710-1110		
3"x 4".....	710-1610		

Yes We Can!

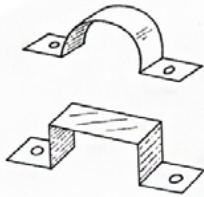

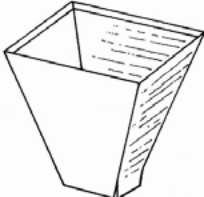
Phone (408) 275-6370
 Fax (408) 881-0177
 sales@acostamfg.com
 www.acostamfg.com

Conductor/Leader Pipe Strap	Size	Item #		
 	1.75" x 2.75".....	710-8005		
	2" x 3".....	710-8010		
	3" x 4".....	710-8015		
	2".....	712-8002		
	3".....	712-8003		
	4".....	712-8004		
Conductor Head	Size	Item #		
 	1.75" x 2.75" to 4" x 6".....	710-9010		
	1.75" x 2.75" to 6" x 8".....	710-9012		
	2" x 3" to 6" x 8".....	710-9020		
	3" x 4" to 6" x 8".....	710-9030		
	1.75" x 2.75" to 9" x 9".....	710-9014		
	3" x 4" to 8" x 10".....	710-9032		
	3" x 4" to 10" x 12".....	710-9034		
Conductor Elbow	Size	Item #		
		<i>45 degree</i>	<i>75 degree</i>	<i>90 degree</i>
	2".....	712-9402.....	712-9702.....	712-9902
	2" Copper.....	713-9402.....	713-9702	
	3".....	712-9403.....	712-9703.....	712-9903
	3" Copper.....	713-9403.....	713-9703	
	4".....	712-9404.....	712-9704	
	1.75" x 2.75".....	712-9010.....	712-9011.....	712-9012
Drop Outlet	Size	Item #		
	2" Tapered.....	709-3010		
	3" K Style Tapered.....	709-3011		



Yes We Can!

Acosta

Sheet Metal Manufacturing, Inc.

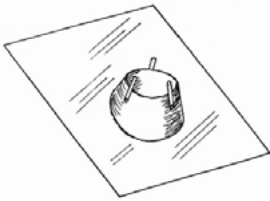

Phone (408) 275-6370
 Fax (408) 881-0177
 sales@acostamfg.com
 www.acostamfg.com

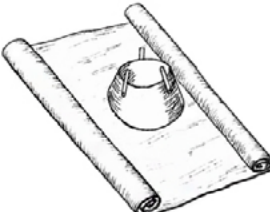
Code Cap Base	Size	Item #		
		All pitch (0-5/12) Regular	All pitch (6/12-12/12) Shake	
	3"	410-0310	410-0315	
	4"	410-0410	410-0415	
	5"	410-0510	410-0515	
	6"	410-0610	410-0615	
	7"	410-0710	410-0715	
	8"	410-0810	410-0815	
	10"	410-1010	410-1015	
	12"	410-1210	410-1215	
	Oval			
	4" (Horizontal)	410-2410	410-2415	
	4" (Vertical)	410-2411	410-2416	
	6" (Horizontal)	410-2610	410-2615	
6" (Vertical)	410-2611	410-2616		
				
				

• Entire piece made from 0.025 Aluminum

Lead Base

Kick/Tile Base

3"	410-0325	410-0320
4"	410-0425	410-0420
5"	410-0525	410-0520
6"	410-0625	410-0620
7"	410-0725	410-0720
8"	410-0825	410-0820
10"	410-1025	410-1020
4" Oval (Horizontal)	410-2425	410-2420
4" Oval (Vertical)	410-2426	410-2421
6" Oval (Horizontal)	410-2625	410-2620
6" Oval (Vertical)	410-2626	410-2621

- Adjustable 0 to 5/12
- Code Cap connector made from 0.025 Aluminum
- 2# (pound) lead or 0.025 Aluminum used for base
- I.C.B.O. ES-ER No 3211
- U.L. Approved

Yes We Can!

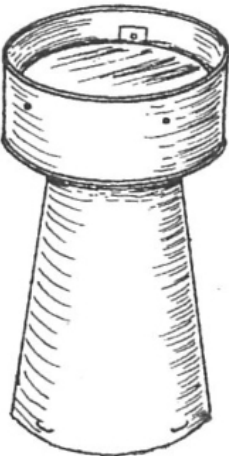
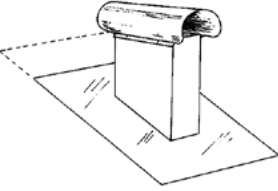

Phone (408) 275-6370
 Fax (408) 881-0177
 sales@acostamfg.com
 www.acostamfg.com

Code Cap Top	Size	Item #			
<div data-bbox="110 508 214 577" style="border: 1px solid black; padding: 2px;"> PRIDE OF SMW 104 Production A-000001 </div> 	3"	410-0305			
	4"	410-0405			
	5"	410-0505			
	6"	410-0605			
	7"	410-0705			
	8"	410-0805			
	10"	410-1005			
	12"	410-1205			
	<i>Oval</i>				
	4"	410-2405			
	6"	410-2605			
	<ul style="list-style-type: none"> • I.C.B.O. ES-ER No 3211 • Entire piece made from 0.025 Aluminum 				
	Roof Jack (Square Top)	Size	Item #		
	<div data-bbox="110 1306 214 1375" style="border: 1px solid black; padding: 2px;"> PRIDE OF SMW 104 Production A-000001 </div> 	<i>Flat</i>		<i>Regular Base</i>	<i>Shake Base</i>
				<i>Horizontal</i>	<i>Horizontal</i>
4"x10"		450-0005	450-1405	450-2405	
4"x12"		450-0010	450-1410	450-2410	
4"x14"		450-0015	450-1415	450-2415	
		<i>Vertical</i>	<i>Vertical</i>		
4"x10"			450-1420	450-2420	
4"x12"			450-1425	450-2425	
4"x14"			450-1430	450-2430	



Yes We Can!

Acosta

Sheet Metal Manufacturing, Inc.

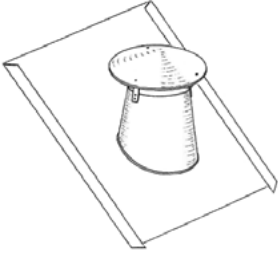

Phone (408) 275-6370
 Fax (408) 881-0177
 sales@acostamfg.com
 www.acostamfg.com

Roof Jack/Fan Jack (Kick Base)	Size	Item #			
 <p>PRIDE OF SMW 104 Production A-000001</p>		4/12	5/12	6/12	
	4".....	455-3404.....	455-3504.....	455-3604	
	5".....	455-3405.....	455-3505.....	455-3605	
	6".....	455-3406.....	455-3506.....	455-3606	
	7".....	455-3407			
	8".....	455-3408.....	455-3508.....	455-3608	
	10".....	455-3410			
	12".....	455-3412			
	14".....	455-3414			
	Roof Jack/Fan Jack (Lead Base)	Size	Item #		
 <p>PRIDE OF SMW 104 Production A-000001</p>		4/12	5/12	6/12	
	4".....	455-4404.....	455-4504.....	455-4604	
	5".....	455-4405.....	455-4505.....	455-4605	
	6".....	455-4406.....	455-4506.....	455-4606	
	7".....	455-4407.....	455-4507.....	455-4607	
	8".....	455-4408.....	455-4508.....	455-4608	
	10".....	455-4410			
	12".....	455-4412			
	14".....	455-4414			





Yes We Can!

Acosta

Sheet Metal Manufacturing, Inc.

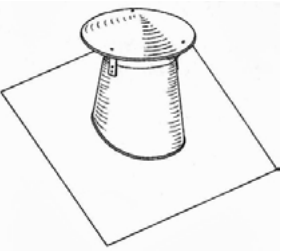
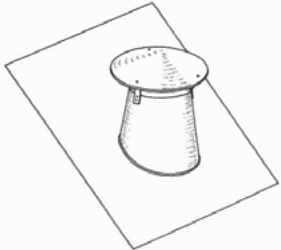

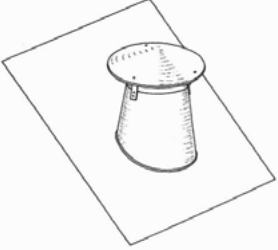
Phone (408) 275-6370
 Fax (408) 881-0177
 sales@acostamfg.com
 www.acostamfg.com

Roof Jack/Fan Jack (Regular Base)	Size	Item #			
 	Flat	4/12	5/12	6/12	
	4".....455-0004.....	455-1404.....	455-1504.....	455-1604	
	5".....455-0005.....	455-1405.....	455-1505.....	455-1605	
	6".....455-0006.....	455-1406.....	455-1506.....	455-1606	
	7".....455-0007.....	455-1407			
	8".....455-0008.....	455-1408.....	455-1508.....	455-1608	
	10".....455-0010.....	455-1410			
	12".....455-0012.....	455-1412			
	14".....455-0014.....	455-1414			
	<ul style="list-style-type: none"> • 26 gauge Galvanized* Steel base plate and cap • F.H.A. plate 				
	Roof Jack/Fan Jack (Shake Base)	Size	Item #		
	 	4/12	5/12	6/12	
4".....455-2404.....		455-2504.....	455-2604		
5".....455-2405.....		455-2505.....	455-2605		
6".....455-2406.....		455-2506.....	455-2606		
7".....455-2407.....					
8".....455-2408.....		455-2508.....	455-2608		
10".....455-2410.....					
12".....455-2412.....					
14".....455-2414.....					
<ul style="list-style-type: none"> • 26 gauge Galvanized* Steel base plate and cap • F.H.A. plate 					
Roof Safe	Size	Item #			
 	8" x 8" (3 Piece).....	410-0000			

Yes We Can!

Acosta

Sheet Metal Manufacturing, Inc.

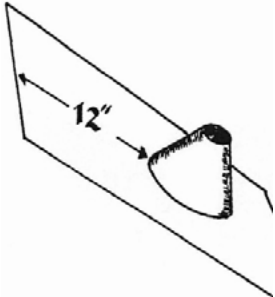
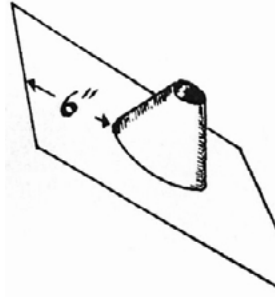

Phone (408) 275-6370
 Fax (408) 881-0177
 sales@acostamfg.com
 www.acostamfg.com

Roof Flashing (Flat)	Size	Item #			
		Flat Base	Regular Base	Shake Base	Kick/Tile Base
 	0.5"	440-0003	440-1003	440-1503	440-2003
	0.75"	440-0006	440-1006	440-1506	440-2006
	1"	440-0009	440-1009	440-1509	440-2009
	1.5"	440-0012	440-1012	440-1512	440-2012
	2"	440-0015	440-1015	440-1515	440-2015
	2.5"	440-0018	440-1018	440-1518	440-2018
	3"	440-0021	440-1021	440-1521	440-2021
	3" D.W.		440-1023	440-1523	440-2023
	4"	440-0024	440-1024	440-1524	440-2024
	4" D.W.		440-1026	440-1526	
	5"	440-0027	440-1027	440-1527	440-2027
	5" D.W.		440-1029	440-1529	
	6"	440-0030	440-1030	440-1530	440-2030
	6" D.W.		440-1032	440-1532	440-2032
	7"	440-0033	440-1033	440-1533	440-2033
	8"	440-0036	440-1036	440-1536	440-2036
	8" D.W.		440-1038	440-1538	440-2038
	9"		440-1039	440-1539	440-2039
	10"	440-0042	440-1042	440-1542	440-2042
	12"	440-0045	440-1045	440-1545	440-2045
	14"	440-0048	440-1048	440-1548	440-2048
	16"	440-0051			
	18"	440-0054			
	20"	440-0057			
22"	440-0060				
24"	440-0063				

- Adjustable pitch 0 to 5/12
- "Flat" is for a no pitch roof only
- 6" base all sides
- F.H.A. plate
- Made with 26 gauge Galvanized Steel

Yes We Can!

Acosta

Sheet Metal Manufacturing, Inc.



Phone (408) 275-6370
 Fax (408) 881-0177
 sales@acostamfg.com
 www.acostamfg.com

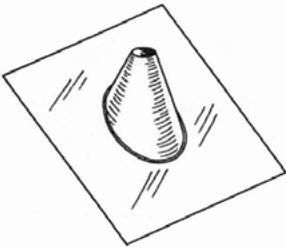
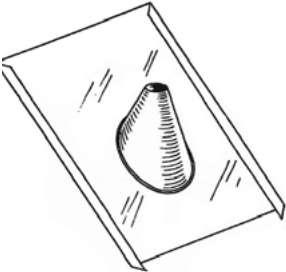
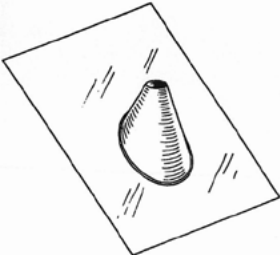

Roof Flashing (Pitch)	Size	Item #		
		Regular Base	Shake Base	Kick/Tile
   	0.5"	440-3003	440-3503	440-4003
	0.75"	440-3006	440-3506	440-4006
	1"	440-3009	440-3509	440-4009
	1.5"	440-3012	440-3512	440-4012
	2"	440-3015	440-3515	440-4015
	2.5"	440-3018	440-3518	440-4018
	3"	440-3021	440-3521	440-4021
	3" D.W.	440-3023	440-3523	440-4023
	4"	440-3024	440-3524	440-4024
	4" D.W.	440-3026	440-3526	440-4026
	5"	440-3027	440-3527	440-4027
	5" D.W.	440-3029	440-3529	440-4029
	6"	440-3030	440-3530	440-4030
	6" D.W.	440-3032	440-3532	440-4032
	7"	440-3033	440-3533	440-4033
	7" D.W.	440-3035	440-3535	440-4035
	8"	440-3036	440-3536	440-4036
	8" D.W.	440-3038	440-3538	440-4038

- Adjustable 6/12 to 12/12
- F.H.A. plate

Yes We Can!

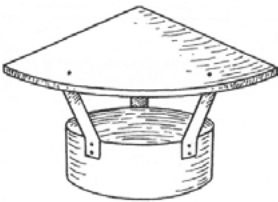

Phone (408) 275-6370
 Fax (408) 881-0177
 sales@acostamfg.com
 www.acostamfg.com

Roof Flashing (Lead Base)	Size	Item #
 		<p style="text-align: center;"><i>Single Wall</i> <i>Double Wall</i></p>
	0.5".....	440-2503
	0.75".....	440-2506
	1".....	440-2509
	1.5".....	440-2512
	2".....	440-2515
	2.5".....	440-2518
	3".....	440-2521.....440-2523
	4".....	440-2524.....440-2526
	5".....	440-2527.....440-2529
	6".....	440-2530.....440-2532
	7".....	440-2533
	8".....	440-2536.....440-2538
	10".....	440-2542
	12".....	440-2545
14".....	440-2548	
China Cap	Size	Item #
 	4".....	480-0604
	5".....	480-0605
	6".....	480-0606
	7".....	480-0607
	8".....	480-0608
	10".....	480-0610
	12".....	480-0612
	14".....	480-0614
	16".....	480-0616
	18".....	480-0618
	20".....	480-0620
	22".....	480-0622
24".....	480-0624	
<p>• <i>Designed for single wall pipe</i></p>		

Yes We Can!









Phone (408) 275-6370
 Fax (408) 881-0177
 sales@acostamfg.com
 www.acostamfg.com

Draft Diverter	Size	Item #
<div data-bbox="110 504 214 577"> <p>PRIDE OF SMW 104 Production A-000001</p> </div> <div data-bbox="110 745 389 976"> </div>	<p>10".....480-1110 12".....480-1112 14".....480-1114 16".....480-1116 18".....480-1118</p>	
Eyebrow Vent	Size	Item #
<div data-bbox="110 1396 214 1470"> <p>PRIDE OF SMW 104 Production A-000001</p> </div> <div data-bbox="110 1606 389 1753"> </div>	<p>26 Gauge Regular Base.....500-5005 26 Gauge Shake Base.....500-5010 Kick for Tile500-5015 Lead Base.....500-5020</p>	

Yes We Can!







Phone (408) 275-6370
 Fax (408) 881-0177
 sales@acostamfg.com
 www.acostamfg.com

Gravity Vent	Size	Item #			
		Top	Base	Damper with Chain	
   	26 Gauge				
	8".....	500-0508.....	500-0608.....	500-0708	
	10".....	500-0510.....	500-0610.....	500-0710	
	12".....	500-0512.....	500-0612.....	500-0712	
	14".....	500-0514.....	500-0614.....	500-0714	
	16".....	500-0516.....	500-0616.....	500-0716	
	24 Gauge				
	18".....	500-0518.....	500-0618.....	500-0718	
	20".....	500-0520.....	500-0620.....	500-0720	
	22".....	500-0522.....	500-0622.....	500-0722	
	24".....	500-0524.....	500-0624.....	500-0724	
	26".....	500-0526.....	500-0626.....	500-0726	
	28".....	500-0528.....	500-0628.....	500-0728	
	30".....	500-0530.....	500-0630.....	500-0730	
	Storm Collar	Size	Item #		
	 	4".....	480-1004		
		6".....	480-1006		
		8".....	480-1008		
10".....		480-1010			
12".....		480-1012			
14".....		480-1014			
16".....		480-1016			
18".....		480-1018			
20".....		480-1020			
22".....		480-1022			
24".....		480-1024			

Yes We Can!

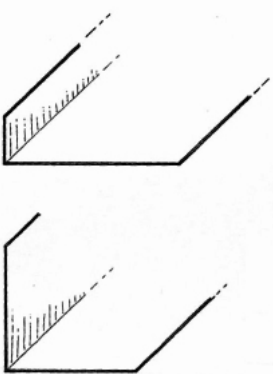

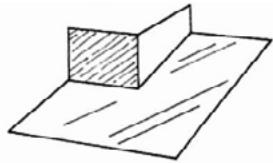

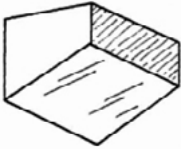
Phone (408) 275-6370
 Fax (408) 881-0177
 sales@acostamfg.com
 www.acostamfg.com

Angle Flashing 90 Degree	Size	Item #			
 		26 Gauge	22 Gauge	18 Gauge	16 Gauge
	1" x 3".....	600-3044			
	1" x 4".....	600-3048			
	1.5" x 1.5".....	600-3004.....		600-3008.....	600-3012
	2" x 2".....	600-3016.....	600-3020.....	600-3024.....	600-3028
	3" x 3".....	600-3032			
	3" x 6".....	600-3052			
	4" x 4".....	600-3036			
	4" x 6".....	600-3056			
	4" x 12".....	600-3060			
	4" x 14".....	600-3064			
	6" x 6".....	600-3040			
Corner	Size	Item #			
 		Upper Left	Lower Left	Upper Right	Lower Right
	4/12.....	600-4024.....	600-4064.....	600-4044.....	600-4084
	5/12.....	600-4025.....	600-4065.....	600-4045.....	600-4085
	6/12.....	600-4026.....	600-4066.....	600-4046.....	600-4086
Inside Corner	Size	Item #			
 					
	4/12.....	600-4004			
	5/12.....	600-4005			
	6/12.....	600-4006			
		<ul style="list-style-type: none"> • All joints 50/50 soldered • Spot welded and soldered • Available in 2# (pound) and 4# (pound) lead base 			

Yes We Can!

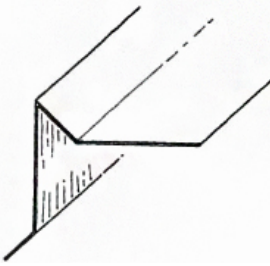

Phone (408) 275-6370
 Fax (408) 881-0177
 sales@acostamfg.com
 www.acostamfg.com

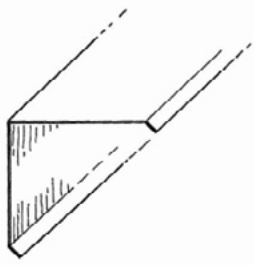
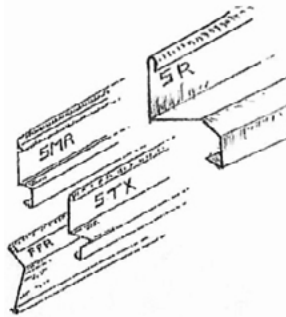
Gravel Stop	Size	Item #	
 		<i>With Kick</i>	<i>With Grip</i>
	2"x 2".....	600-0620.....	600-0520
	3"x 3".....	600-0630.....	600-0530
Nosing	Size	Item #	
 		<i>With Kick</i>	<i>With Grip</i>
	1.5"x 1.5".....	600-1110.....	600-1010
	2"x 2".....	600-1115.....	600-1015
	3"x 3".....	600-1120.....	600-1020
Reglet	Size	Item #	
		Surface Mount.....	600-5505
	Stucco.....	600-5510	
	Flashing.....	600-5515	

Yes We Can!

Acosta

Sheet Metal Manufacturing, Inc.

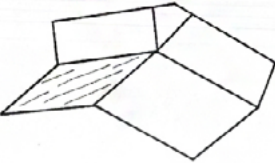
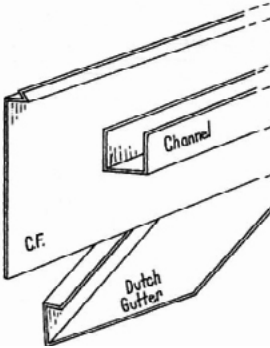
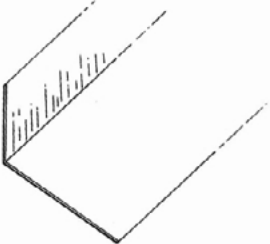

Phone (408) 275-6370
 Fax (408) 881-0177
 sales@acostamfg.com
 www.acostamfg.com

Ridge Flashing	Size	Item #	
 <p>PRIDE OF SMW104 Production A-000001</p>	4/12..... 5/12..... 6/12.....600-5004600-5005600-5006	
Roofing Metals	Size	Item #	
		Tile Pan Flashing (4"x 7"x 1").....600-8505 Dutch Gutter (Rain Diverter).....600-6510 Termite Flashing (4"x 8"x 1").....600-8515 6" Counter Flashing.....600-6010 90 Degree Channel (1"x 1.125"x 1").....600-7010	
Roof to Wall	Size	Item #	
 <p>PRIDE OF SMW104 Production A-000001</p>	4/12..... 5/12..... 6/12.....	3x6600-2304.....600-2305.....600-2306.....	4x6600-2404600-2405600-2406

Yes We Can!

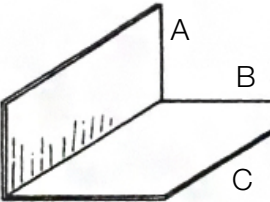
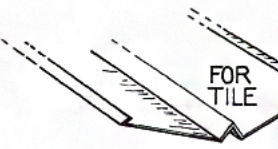
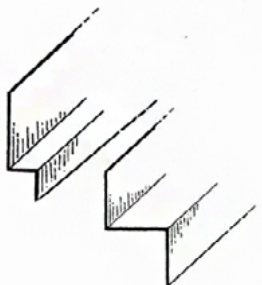

Phone (408) 275-6370
 Fax (408) 881-0177
 sales@acostamfg.com
 www.acostamfg.com

Step Shingle	Size	Item #
 <p>PRIDE OF SMW 104 Production A-000001</p>	<p>AxBxC</p> <p>3"x 5"x 7".....600-8005</p> <p>4"x 5"x 7".....600-8010</p> <p>4"x 6"x 12".....600-8015</p> <p>4"x 6"x 14".....600-8020</p>	
W Valley	Size	Item #
 <p>PRIDE OF SMW 104 Production A-000001</p>	<p>10' Long</p> <p>18".....600-1505</p> <p>24".....600-1510</p> <p>24" for Tile.....600-1515</p>	
Z-Bar	Size	Item #
 <p>PRIDE OF SMW 104 Production A-000001</p>	<p>1"x 3/8"x 1/2".....600-7510</p> <p>1"x 5/8"x 1/2".....600-7515</p> <p>2"x 1 1/2"x 1/2".....600-7520</p>	

This page intentionally left blank

ASSORTED ACCESSORIES



Assorted metals and accessories for commercial and residential needs



Yes We Can!

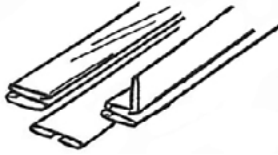

Phone (408) 275-6370
 Fax (408) 881-0177
 sales@acostamfg.com
 www.acostamfg.com

"S" and Drive Clip	Size	Item #
 		Galvanized 304 2B Stainless Steel
	"S" Clip 120" long.....	270-3005.....270-3301
	"D"/Drive Clip 120" long.....	270-3205.....270-3302
	Standing "S" Clip 120" long.....	270-3105
Duct Liner and Pins	Size	Item #
	0.5"x 48"x 100 feet.....	300-0505
	1"x 48"x 100 feet.....	300-0510
	1"x 60"x 100 feet.....	300-0511
	1.5"x 48"x 50 feet.....	300-0513
	1.5"x 60"x 50 feet.....	300-0514
	1"x 47"x 100 feet.....	301-4710
	1"x 59"x 100 feet.....	301-5910
	1.5"x 59"x 50 feet.....	301-5915
Duro Dyne Accessories	Size	Item #
	Ductmate 35 in in 10' lengths.....	270-2006/ per foot
	Ductmate 35 in 20' lengths.....	270-2005 /per foot
	Ductmate Corners 111 A.....	270-2105 /each
	Ductmate Gasket roll 25' long.....	270-2205 /per roll
	Ductmate PVC Cleats 6" long.....	270-2110 /each
	TDC Metal Cleats.....	270-2111 /each
	TDC Flex Connector (4x4x4) 100' long.....	270-6006 /per box
	Flex Connector (3x3x3) 100' long.....	270-6005 /per box
	Ductmate Metal Cleats 6" long.....	270-2112 /each
	2" Turning Vane.....	270-1005 /per foot
	4" Turning Vane.....	270-1006 /per foot
	2" Turning Vane Rail.....	270-1105 /per foot
4" Turning Vane Rail.....	270-1106 /per foot	

Phone (408) 275-6370
 Fax (408) 881-0177
 sales@acostamfg.com
 www.acostamfg.com

Yes We Can!

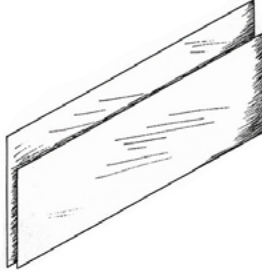
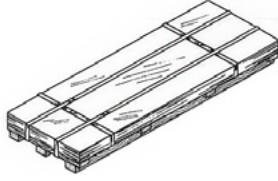

Flat Sheet	Size	Item #				
		Galvanized	304 2B Stainless	316 2B Stainless	#4 PVC Stainless	Bonderized
 	36"x 120":					
	30 Gauge....	280-1025				
	28 Gauge....	280-1136				
	26 Gauge....	280-1236.....	812-6010			
	24 Gauge....	280-1336.....	812-5010			
	22 Gauge....	280-1436.....	812-4010.....		812-4020	
	20 Gauge....	280-1536.....	812-3010.....		812-3020	
	48"x 120":					
	28 Gauge....	280-1148				
	26 Gauge....	280-1248.....	812-6030.....			811-6030
	24 Gauge....	280-1348.....	812-5030.....	812-5050.....	812-5040.....	811-5030
	22 Gauge....	280-1448.....	812-4030.....	812-4050.....	812-4040	
	20 Gauge....	280-1548.....	812-3030.....	812-3050.....	812-3040	
	18 Gauge....	4812018.....	812-2030.....		812-2040	
	16 Gauge....	810-1030.....	812-1030.....		812-1040	
	14 Gauge....	810-0030				
	12 Gauge....	810-0020		Aluminum: (48" x 120")		
	10 Gauge....	810-0010		0.032.....	814-2030	
				0.025.....	814-2530	
				0.050.....	814-3030	
				0.063.....	814-4030	
	26 Gauge:					
	4"x 120"....	280-1204		Cold Rolled: (48" x 120")		
	6"x 120"....	280-1206		16 Gauge.....	816-1030	
	8"x 120"....	280-1208		18 Gauge.....	816-2030	
	9"x 120"....	280-1209		Jet Coat: (48" x 120")		
	10"x 120"....	280-1210		22 Gauge.....	811-4030	
	12"x 120"....	280-1212		24 Gauge.....	811-3030	
	18"x 120"....	280-1218		Galvanized: (60"x 120")		
	24"x 120"....	280-1224		26 Gauge.....	280-1260	
	24 Gauge:			24 Gauge.....	280-1360	
	24"x 24"....	280-1265		22 Gauge.....	280-1460	
	24"x 48"....	280-1266		20 Gauge.....	280-1560	
	48"x 48"....	280-1275		18 Gauge.....	810-2080	
	48"x 60"....	280-1276		16 Gauge.....	810-1080	



Yes We Can!

Acosta

Sheet Metal Manufacturing, Inc.

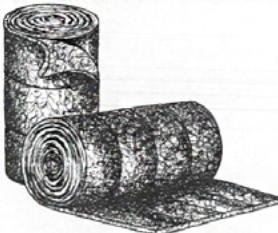
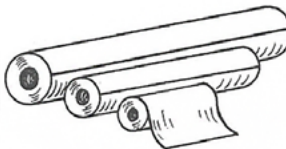

Phone (408) 275-6370
 Fax (408) 881-0177
 sales@acostamfg.com
 www.acostamfg.com

Insulation (Rolls)	Size	Item #
	<i>Fiber Glass</i>	
	9"x 150 feet.....	300-1005
	12"x 150 feet.....	300-1010
	36"x 150 feet.....	300-1015
	<i>Foil Back Insulation</i>	
	48"x 100 feet.....	300-1505
	Lead Rolls	Size
		Item #
	<i>2# (pound)</i>	
	9.625"x 240".....	266-0509
	12"x 240".....	266-0512
	24"x 240".....	266-0524
48"x 240".....	266-0548	
<i>4# (pound)</i>		
30"x 300".....	266-0618	
48"x 300".....	266-0620	
Screws and Panduit Strap	Size	Item #
	Zip Screws #8: 0.5" (1,000).....	270-0505 /per box
	Self Tapping Screws #8: 0.5" (1,000).....	270-0510 /per box
	Self Tapping Screws #10: 3/4" (1,000).....	270-0511 /per box
	Ductmate Nuts and Bolts (100).....	840-2012 /per box
	Panduit Straps 36" (50 piece per bag).....	250-0036 /per bag
	Panduit Straps 48" (50 pieces per bag).....	250-0048 /per bag

Yes We Can!

Acosta

Sheet Metal Manufacturing, Inc.



Phone (408) 275-6370
 Fax (408) 881-0177
 sales@acostamfg.com
 www.acostamfg.com

Sealant and Solder	Size	Item #	
	<i>5/16 Tri-bar Solder</i>		
	Stick.....	265-0505	
	50 pound box.....	265-0510	
	Sal Ammoniac.....	265-5005	
	<i>Sealant:</i>		
	Sikaflex.....	255-0000	
	<i>DP1010</i>		
	Tube.....	255-0510	
	1 Gallon Tub.....	255-0505	
	<i>DP1020</i>		
1 Gallon Tub.....	255-0506		
Strap	Size	Item #	
	1" x 60 Feet Roll 22 Gauge.....	290-1022 /per box	
	1.5" x 100 Feet Roll 26 Gauge.....	290-1526 /per box	
	1" x 10 Feet Long 22 Gauge.....	290-0022 /per foot	
	1" x 10 Feet Long 18 Gauge.....	290-0018 /per foot	
	1.5" x 10 Feet Long 24 Gauge.....	290-1524 /per foot	
	1.5" x 10 Feet Long 22 Gauge.....	290-1522 /per foot	
	Tape, Glue, Visqueen, Accessories	Size	Item #
	<i>Duct Tape</i>		
	2" x 180 feet (398) Grey	250-0020	
	2" x 360 feet (555 U.L.) Black	250-0021	
	2" x 360 feet (555 U.L.) Silver	250-0023	
	2" x 180 feet (557 U.L.) Black.....	250-0022	
	2" x 180 feet (558 U.L. 181-B) Silver.....	250-0024	
	<i>Foil Tape</i>		
	2" x 150 feet.....	250-1020	
	2.5" x 180 feet (181A U.L.).....	250-1030	
	3" x 150 feet (FSK).....	250-2030	
	2" x 50 feet (BUTYL).....	250-3020	
	<i>Glue: 357 Spray Adhesive Glue.....</i>		270-8005
	Visqueen 24" x 200 Feet Long		270-1000
	1" Paint Brush		880-0025
2" Paint Brush		880-0026	

Yes We Can!

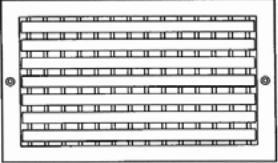
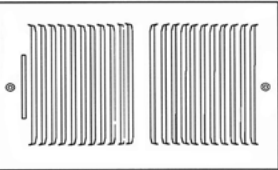
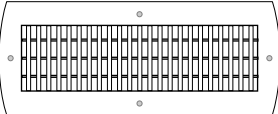

Phone (408) 275-6370
 Fax (408) 881-0177
 sales@acostamfg.com
 www.acostamfg.com

Ceiling Register (Shoemaker)	Size	Item #
		
	10" x 10"	501-2046
	12" x 12"	501-2047
Wall-Ceiling Register (Shoemaker)	Size	Item #
	10" x 4"	501-2040
	10" x 6"	501-2041
	12" x 6"	501-2042
	14" x 6"	501-2043
	12" x 8"	501-2044
	14" x 8"	501-2045
	12" x 4"	501-2048
	14" x 4"	501-2049
Spiral Double Grille (Shoemaker)	Size	Item #
	10" x 4" on 8"	501-4001
	10" x 6" on 10"	501-4002
	12" x 4" on 8"	501-4003
	12" x 6" on 10"	501-4004
	14" x 4" on 8"	501-4005
	14" x 6" on 10"	501-4006
	14" x 8" on 12"	501-4007
	16" x 6" on 10"	501-4008
	16" x 8" on 12"	501-4009

Yes We Can!

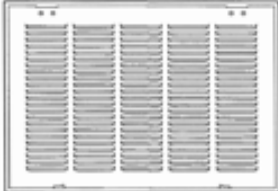
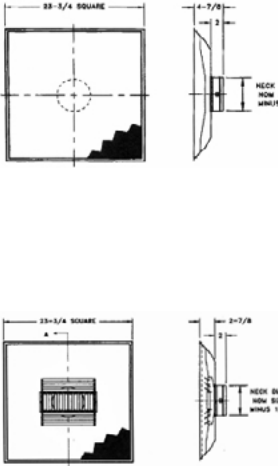

Phone (408) 275-6370
 Fax (408) 881-0177
 sales@acostamfg.com
 www.acostamfg.com

Return-Air Filter Grille (Shoemaker)	Size	Item #			
	14"x 14"	501-3014			
	20"x 14"	501-3020			
	24"x 14"	501-3024			
	25"x 14"	501-3025			
T-Bar (Return and Supply Air)	Size	Item #			
		<table border="0"> <thead> <tr> <th></th> <th><i>Return</i></th> <th><i>Supply</i></th> </tr> </thead> </table>		<i>Return</i>	<i>Supply</i>
		<i>Return</i>	<i>Supply</i>		
	6"	501-3032	501-2054		
	8"	501-3031	501-2053		
	10"	501-3026	501-2050		
	12"	501-3027	501-2051		
	14"	501-3028	501-2052		
	16"	501-3029			
18"	501-3030				

Yes We Can!

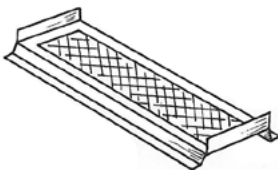
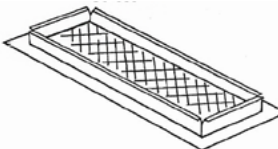
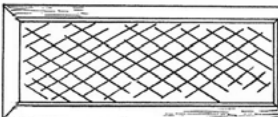

Phone (408) 275-6370
 Fax (408) 881-0177
 sales@acostamfg.com
 www.acostamfg.com

Eave Vent	Size	Item #
	3.5" x 14".....	500-7005
	3.5" x 22".....	500-7010
	5.5" x 14".....	500-7015
	5.5" x 22".....	500-7020
	7.5" x 14".....	500-7025
	7.5" x 22".....	500-7030
Foundation Vent (Stucco)	Size	Item #
	1/4" Mesh	
	14" x 4".....	500-8014
	14" x 6".....	500-8016
	14" x 8".....	500-8018
Foundation Vent (Flat)	Size	Item #
	1/4" Mesh	
	14" x 4".....	500-8004
	14" x 6".....	500-8006
	14" x 8".....	500-8008

Yes We Can!

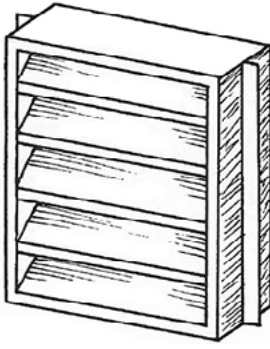
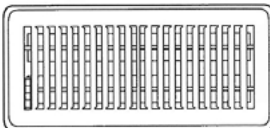

Phone (408) 275-6370
 Fax (408) 881-0177
 sales@acostamfg.com
 www.acostamfg.com

Gable Vent	Size	Item #
	14" x 8"	500-6008
	14" x 12"	500-6012
	14" x 18"	500-6018
	14" x 24"	500-6024
Floor Vent (Shoemaker)	Size	Item #
	<i>Toe Kick</i>	
	2.25" x 14"	501-1024
	<i>Floor Register</i>	
	4" x 10"	501-1040
	4" x 12"	501-1042
4" x 14"	501-1044	

This page intentionally left blank

Index

Acoustical Flex (with or without Damper)	8
Adjustable Elbows	28-29
Aluma Flex (Insulated or Bare)	9
Alumasprial Pipe	9
Angle Flashing (90 Degree)	66
Assorted Accessories	72-80
Blast Gate Damper	42
Ceiling Box (Rectangular/Square)	40
Ceiling Register (Shoemaker)	76
China Cap	63
Code Cap Bases	57
Code Cap Top	58
Collar	41
Collar with Damper	42
Conductor Elbow	56
Conductor Head	56
Leader/Conductor Pipe	55
Conductor/Leader Pipe Strap	56
Conical Tap	34
Corner	66
Damper Blade/Disc	42
Draft Diverter	63
Drive Clip and "S" Clip	72
Drop Outlet	56
Dryer Vent	52
Duct Liner and Pins	72
Duraflange	21
Duravent	10
Duro Dyne Accessories	72
Dust Cover	52
Eave Vent	78
Elbows	28-31
Adjustable (45 and 90 Degree)	28-29
Long Radius Adjustable (45 and 90 Degree)	30
Spiral Elbow (45 and 90 Degree)	18, 30
Spot and Sealed (22.5, 45, and 90 Degree)	31
End Cap (Round)	43
Eyebrow Vent	64
F-1 Single Register Box	50

Index

F-5 Straight Boot	46
F-13 Angle Boot 90 Degree	46
F-17 Cone Boot	46
Fan Boot	47
Fan Jacks/Roof Jacks	58-60
Square Top	58
Kick Base	59
Lead Base	59
Regular Base	60
Shake Base	60
Flat Sheets	73
Floor Vent (Shoemaker)	79
Flue Bracket.....	52
Foundation Vents	
Stucco	78
Flat	78
Fresh Air Vents	50
Furnace Pipe	11-12
KD/Snap Lock	11
Stitch Welded	12
Gable Vent	79
Gravel Stop	67
Gravity Vent	64
Gravity Vent Damper with Chain	65
Gutter	54
Gutter and Roofing Products	54-69
Gutter end Cap	54
Gutter Strap	55
Hanger Strap	21
HVAC Fittings and Accessories	40-52
Inside Corner	66
Insulation (Rolls)	74
Leader/Conductor Pipe	55
Lead Rolls	74
Nosing	67
Perimeter Box	49
Perimeter Cover	52
PH 1	47
PH 2	48

Index

PH 2A	48
PH 3	49
Pipe	8-15
Plenum and Cap	12
Rain Hoods	51
“Old Style”	51
For wood	51
For stucco	51
Reducer	43
Reglet	67
Return-Air Filter Grille (Shoemaker)	77
Ridge Flashing	68
Riser Elbow	50
Riser Pipe	12
Roof Flashings	61-62
Flat	61
Pitch	62
Lead Base	62
Roofing Metals	68
Roof Jacks/Fan Jacks	58-60
Square Top	58
Kick Base	59
Lead Base	59
Regular Base	60
Shake Base	60
Roof Safe	60
Roof to Wall	68
Saddle Tap (Rectangular)	34
Saddle Tee	35
Saddle Wye	36
“S” and Drive Clip	72
Screws and Panduit Strap	74
Sealant and Solder	75
Self Stick Collar	34, 41
Spiral Products	18-25
Spiral Pipe	13-14
Spiral Elbow (45, and 90 Degree)	18, 30
Spiral Collar	19
Spiral Double Grille (Shoemaker)	76

Index

Spiral End Cap	20
Spiral Pipe	22-23
Spiral-Helix Ovalizer Chart	24-25
Square to Round	45
Step Shingle	69
Strap	75
Stock Wye Branches	37
Storm Collar	65
Tape, Glue, and Visqueen	75
Taper	44
Taper with Collar	44
Taper with Collar (for Spiral)	20, 45
Tee	35
Tees	34-37
T-Bar (Return and Supply Air)	77
Vent Tee	35
Vent Wye	36
Wall-Ceiling Register (Shoemaker)	76
Wire Flex (with or without collars)	15
W Valley	69
Wyes	34-37
Z-Bar	69

This page intentionally left blank

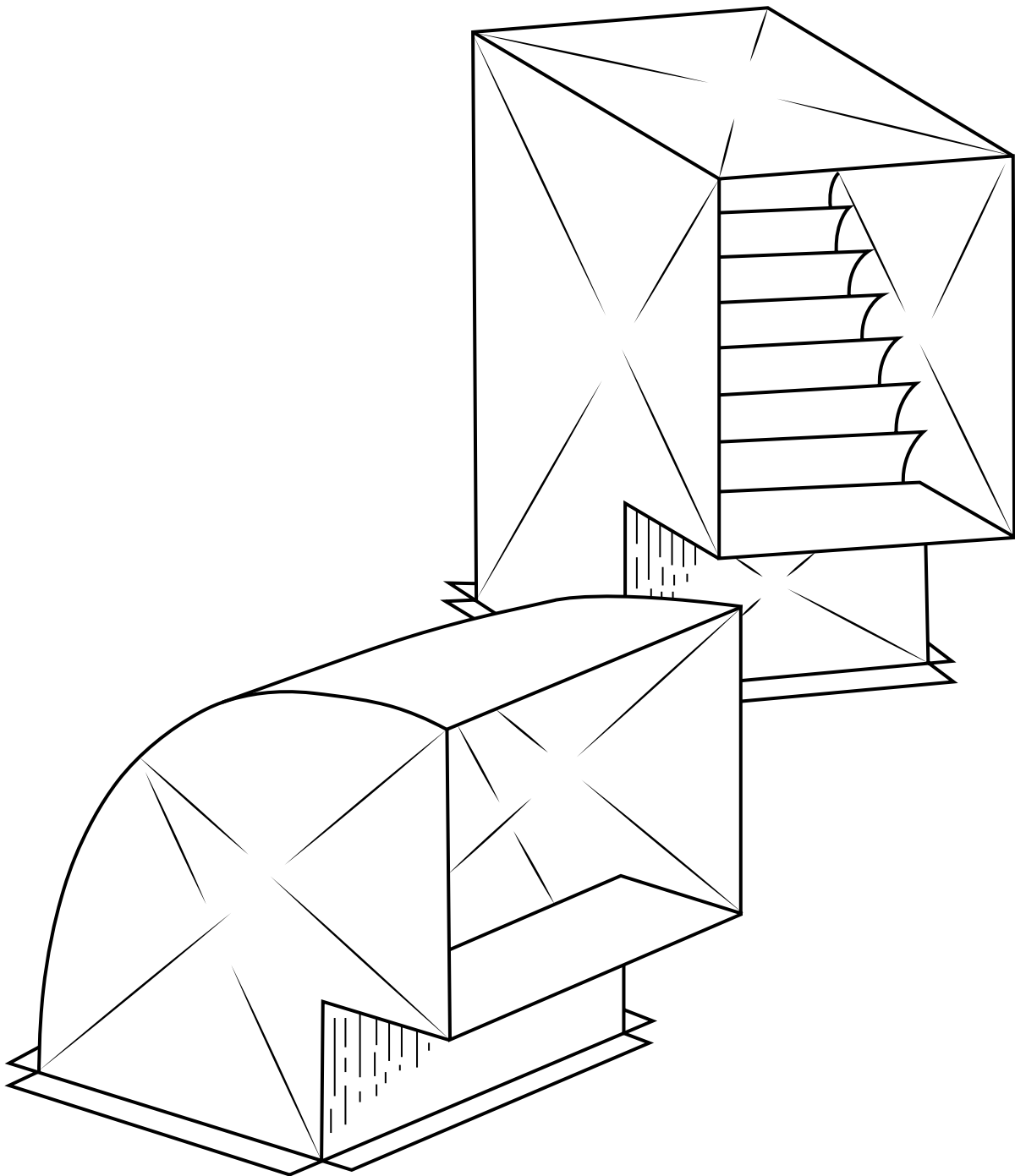

Product Catalog ©2024

www.acostamfg.com | 930 Remillard Court. San Jose, California 95122 | sales@acostamfg.com