

Yes We Can!

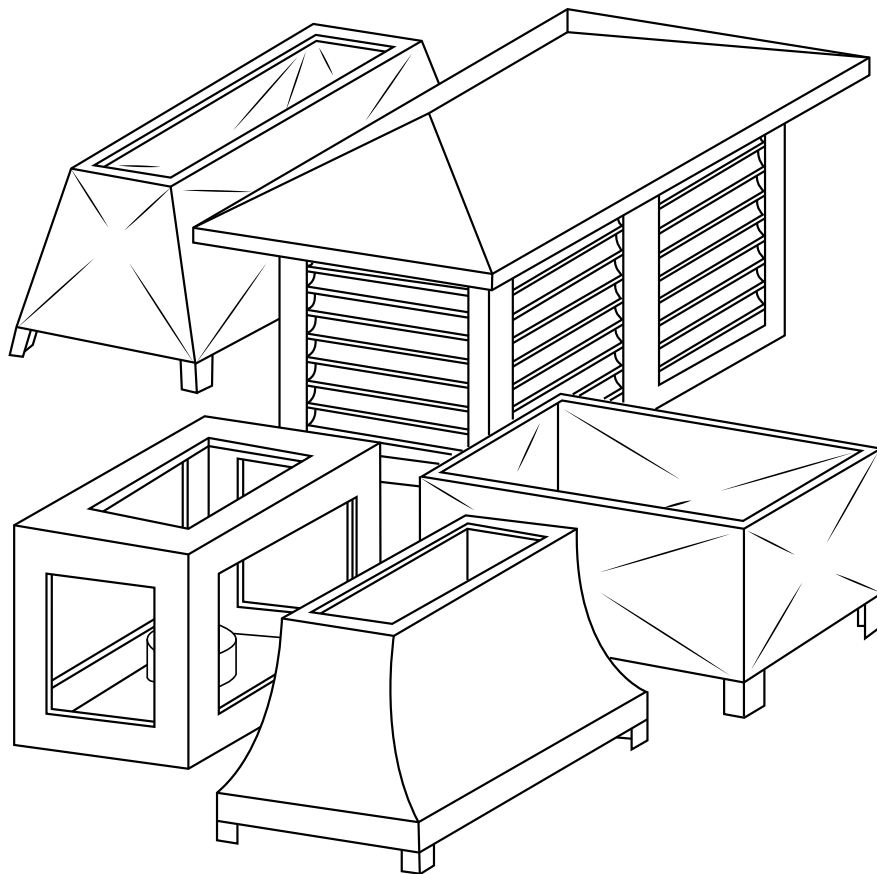

Product Catalog

Catalog Updates: acostamfg.com/products-and-submittals



acostamfg.com | sales@acostamfg.com

This document is digitally navigable—click on any of the links, items in the Table of Contents and Index, headers, footers, and you'll be taken to it's destination. **Note:** web links and emails will be opened in a new window.

(Stock) Product Catalog

Acosta Sheet Metal Mfg.©2025

Published February 12, 2025

Catalog Updates at www.acostamfg.com

Place an Order:

sales@acostamfg.com

www.acostamfg.com/place-order

Product Specification Sheets:

www.acostamfg.com/products-and-submittals

Contact Us:

sales@acostamfg.com

www.acostamfg.com

Phone (408) 766-7215

Sales Fax (408) 297-0130

930 Remillard Court

San Jose, CA 95122



Certified MBE



Table of Contents

Pipe

Acoustical Flex (with or without Damper)	8
Aluma Flex (Insulated or Bare)	9
Alumasprial Pipe	9
Duravent	10
Furnace Pipe	
KD/Snap Lock	11
Stitch Welded	12
Plenum and Cap	12
Riser Pipe	12
Spiral Pipe	13-14
Wire Flex (with or without collars)	15

Spiral

Spiral Elbow (45 and 90 Degree)	18
Spiral Collar	19
Spiral End Cap	20
Taper with Collar (for Spiral)	20
Hanger Strap	21
Duraflange	21
Spiral Pipe	22-23
Spiral-Helix Ovalizer Chart	24-25

Elbows

Adjustable (45 and 90 Degree)	28-29
Long Radius Adjustable (45 and 90 Degree)	30
Spiral Elbow (45 and 90 Degree)	30
Spot and Sealed Elbow (22.5, 45, and 90 Degree)	31

Wyes and Tees

Conical Tap	34
Self Stick Collar	34
Saddle Tap (Rectangular)	34
Saddle Tee	35
Tee	35
Vent Tee	35
Saddle Wye	36
Vent Wye	36
Stock Wye Branches	37

Table of Contents

HVAC Fittings and Accessories

Ceiling Box (Rectangular/Square)	40
Collar	41
Self-Stick Collar	41
Collar with Damper	42
Damper Blade/Disc	42
Blast Gate Damper	42
End Cap (Round)	43
Reducer	43
Taper	44
Taper with Collar	44
Taper with Collar (for Spiral)	45
Square to Round	45
F-5 Straight Boot	46
F-13 Angle Boot 90 Degree	46
F-17 Cone Boot	46
Fan Boot	47
PH 1	47
PH 2	48
PH	48
PH 3	49
Perimeter Box	49
Riser Elbow	50
F-1 Single Register Box	50
Fresh Air Vents	50
Rain Hoods	
“Old Style”	51
For wood	51
For stucco	51
Dust Cover	52
Dryer Vent	52
Perimeter Cover	52
Flue Bracket	52

Table of Contents

Gutter and Roofing

Gutter	54
End Cap	54
Gutter Strap	55
Leader/Conductor Pipe	55
Conductor/Leader Pipe Strap	56
Conductor Head	56
Conductor Elbow	56
Drop Outlet	56
Code Cap Bases	57
Code Cap Top	58
Roof Jacks/Fan Jacks	
Square Top	58
Kick Base	59
Lead Base	59
Regular Base	60
Shake Base	60
Roof Safe	60
Roof Flashings	
Flat	61
Pitch	62
Lead Base	62
China Cap	63
Draft Diverter	63
Eyebrow Vent	64
Gravity Vent	64
Gravity Vent Damper with Chain	65
Storm Collar	65
Angle Flashing (90 Degree)	66
Corner	66
Inside Corner	66
Gravel Stop	67
Nosing	67
Reglet	67
Ridge Flashing	68
Roofing Metals	68
Roof to Wall	68
Step Shingle	69

Table of Contents

W Valley	69
Z-Bar	69

Assorted Accessories

“S” and Drive Clip	72
Duct Liner and Pins	72
Duro Dyne Accessories	72
Flat Sheets	73
Insulation (Rolls)	74
Lead Rolls	74
Screws and Panduit Strap	74
Sealant and Solder	75
Strap	75
Tape, Glue, and Visqueen	75
Ceiling Register (Shoemaker)	76
Wall-Ceiling Register (Shoemaker)	76
Spiral Double Grille (Shoemaker)	76
Return-Air Filter Grille (Shoemaker)	77
T-Bar (Return and Supply Air)	77
Eave Vent	78
Foundation Vents	
Stucco	78
Flat	78
Gable Vent	79
Floor Vent (Shoemaker)	79

PIPEPRODUCTS

Assorted pipe for commercial and residential use







Yes We Can!

Acosta

Sheet Metal Manufacturing, Inc.





Phone (408) 275-6370
 Fax (408) 881-0177
 sales@acostamfg.com
 www.acostamfg.com

Acoustical Flex (without Damper)	Size	Item #			
 		<i>R-value 4.2</i>	<i>R-value 8</i>	<i>R-value 4.2</i>	
		<i>Black Vinyl</i>	<i>Black Vinyl</i>	<i>Silver Vinyl</i>	
	5' Long	6".....	110-3106.....	110-3606.....	110-3306
	8".....	10".....	110-3108.....	110-3608.....	110-3308
	12".....	14".....	110-3110.....	110-3610.....	110-3310
	16".....	18".....	110-3112.....	110-3612.....	110-3312
	20".....	110-3114.....	110-3614.....	110-3614.....	110-3314
	110-3116.....	110-3118.....	110-3616.....	110-3618.....	110-3316
	110-3118.....	110-3120.....	110-3618.....	110-3620.....	110-3318
	110-3120.....	110-3620.....	110-3620.....	110-3620.....	110-3320
<ul style="list-style-type: none"> • Collars taped with 555 U.L. Duct Tape • 2" Water Column 					
Acoustical Flex (with Damper)	Size	Item #			
  		<i>R-value 4.2</i>	<i>R-value 8</i>	<i>R-value 4.2</i>	
		<i>Black Vinyl</i>	<i>Black Vinyl</i>	<i>Silver Vinyl</i>	
	5' Long	6".....	110-3206.....	110-3506.....	110-3406
	8".....	10".....	110-3208.....	110-3508.....	110-3408
	12".....	14".....	110-3210.....	110-3510.....	110-3410
	16".....	18".....	110-3212.....	110-3512.....	110-3412
	20".....	110-3214.....	110-3514.....	110-3514.....	110-3414
	110-3216.....	110-3218.....	110-3516.....	110-3518.....	110-3416
	110-3218.....	110-3220.....	110-3518.....	110-3520.....	110-3418
	110-3220.....	110-3520.....	110-3520.....	110-3520.....	110-3420
<ul style="list-style-type: none"> • Adjustable Collars • 2" Water Column 					

Yes We Can!



Phone (408) 275-6370
 Fax (408) 881-0177
 sales@acostamfg.com
 www.acostamfg.com

Aluma Flex (Insulated)	Size	Item #			
		<i>R-value 4.2 Black Vinyl</i>	<i>R-value 4.2 Black Vinyl & Taped</i>	<i>R-value 8 Black Vinyl</i>	<i>Bare</i>
					<i>10' Long (without collars)</i>
	3".....				110-1103
	4".....				110-1104
	<i>7.5' Long</i>				<i>(with collars)</i>
	5".....	110-1205.....		110-1305.....	110-1105
	6".....	110-1206.....	110-1406.....	110-1306.....	110-1106
	7".....	110-1207.....		110-1307.....	110-1107
	8".....	110-1208.....	110-1408.....	110-1308.....	110-1108
	9".....	110-1209.....		110-1309.....	110-1109
	10".....	110-1210.....	110-1410.....	110-1310.....	110-1110
	12".....	110-1212.....	110-1412.....	110-1312.....	110-1112
	14".....	110-1214.....	110-1414.....	110-1314.....	110-1114
	16".....	110-1216.....	110-1416.....	110-1316.....	110-1116
	18".....	110-1218.....	110-1418.....	110-1318.....	110-1118
	20".....	110-1220.....	110-1420.....	110-1320.....	110-1120
	22".....	110-1222.....	110-1422.....	110-1322.....	110-1122
	24".....	110-1224.....	110-1424.....	110-1324.....	110-1124
					<ul style="list-style-type: none"> • Collars glued and stapled • 10" water column
	Alumaspiral	Size	Item #		
			<i>R-value 4.2 Silver Vinyl</i>	<i>Taped Silver Vinyl</i>	<i>Visqueened Silver Vinyl</i>
<i>7.5' Long</i>					
6".....		125-4206.....	125-4406.....	125-4306	
8".....		125-4208.....	125-4408.....	125-4308	
10".....		125-4210.....	125-4410.....	125-4310	
12".....		125-4212.....	125-4412.....	125-4312	
14".....		125-4214.....	125-4414.....	125-4314	
16".....		125-4216.....	125-4416.....	125-4316	
18".....		125-4218.....	125-4418.....	125-4318	
20".....		125-4220.....	125-4420.....	125-4320	
22".....		125-4222.....	125-4422.....	125-4322	
24".....		125-4224.....	125-4424.....	125-4324	
					<ul style="list-style-type: none"> • *Made to Order: R-value 8

Yes We Can!

Acosta

Sheet Metal Manufacturing, Inc.



Phone (408) 275-6370
 Fax (408) 881-0177
 sales@acostamfg.com
 www.acostamfg.com

Duravent (Double Wall)	Size	Item #			
		3"	4"	5"	
		D.W. Pipe 12" Long.....	380-3112.....	380-4112.....	380-5112
D.W. Pipe 12" Long Adjustable.....		380-3212.....	380-4212.....	380-5212	
D.W. Pipe 18" Long.....		380-3118.....	380-4118.....	380-5118	
D.W. Pipe 24" Long.....		380-3124.....	380-4124.....	380-5124	
D.W. Pipe 36" Long.....		380-3136.....	380-4136.....	380-5136	
D.W. Pipe 48" Long.....		380-3148.....	380-4148.....	380-5148	
D.W. Pipe 60" Long.....		380-3160.....	380-4160.....	380-5160	
45 Degree Elbow.....		380-3304.....	380-4304.....	380-5204	
90 Degree Elbow.....		380-3309.....	380-4309.....	380-5309	
D.W. Storm Collar.....		380-3605.....	380-4605.....	380-5605	
D.W. Tee.....		380-3405.....	380-4405.....	380-5405	
D.W. Tee Cap.....		380-3410.....	380-4410.....	380-5410	
D.W. Vent Top.....		380-3610.....	380-4610.....	380-5610	
			6"	8"	
D.W. Pipe 12" Long.....		380-6112.....	380-8112		
D.W. Pipe 12" Long Adjustable.....		380-6212.....	380-8212		
D.W. Pipe 18" Long.....		380-6118.....	380-8118		
D.W. Pipe 24" Long.....		380-6124.....	380-8124		
D.W. Pipe 36" Long.....		380-6136.....	380-8136		
D.W. Pipe 48" Long.....		380-6148.....	380-8148		
D.W. Pipe 60" Long.....	380-6160.....	380-8160			
45 Degree Elbow.....	380-6304.....	380-8304			
90 Degree Elbow.....	380-6309.....	380-8309			
D.W. Storm Collar.....	380-6605.....	380-8605			
D.W. Tee.....	380-6405.....	380-8405			
D.W. Tee Cap.....	380-6410.....	380-8410			
D.W. Vent Top.....	380-6610.....	380-8610			

Phone (408) 275-6370
 Fax (408) 881-0177
 sales@acostamfg.com
 www.acostamfg.com

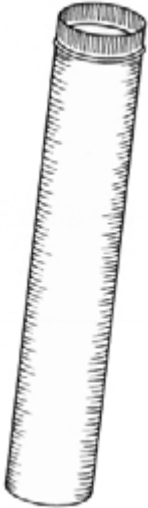

Furnace Pipe (KD/Snap Lock)	Size	Item #				
			<i>Galvanized Steel</i> 26 Gauge 3' Long	<i>Galvanized Steel</i> 24 Gauge 3' Long	<i>Galvanized Steel</i> 26 Gauge 5' Long	
	3".....	113-1203				
	4".....	113-1204.....	115-1204			
	5".....	113-1205.....	115-1205			
	6".....	113-1206.....	115-1206			
	7".....	113-1207.....	115-1207			
	8".....	113-1208.....	115-1208			
	9".....	113-1209.....	115-1209			
	10".....	113-1210.....	115-1210			
	12".....	113-1212.....	115-1212			
	14".....	113-1214.....	115-1214			
	16".....		113-1316			
	18".....		113-1318			
	20".....		113-1320			
	22".....		113-1322			
	24".....		113-1324			
	26".....		113-1326			
			<i>304 2B</i> <i>Stainless Steel</i>	<i>0.025</i> <i>Aluminum</i>		
			3' Long			
	3".....	113-2203.....	114-5203			
		4' Long				
4".....	114-2204.....	114-5204				
5".....	114-2205.....	114-5205				
6".....	114-2206.....	114-5206				
7".....	114-2207.....	114-5207				
8".....	114-2208.....	114-5208				
10".....	114-2210.....	114-5210				
12".....	114-2212.....	114-5212				
14".....	114-2214.....	114-5214				

Yes We Can!

Acosta

Sheet Metal Manufacturing, Inc.

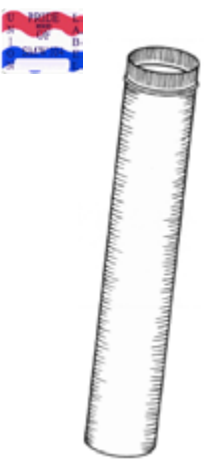
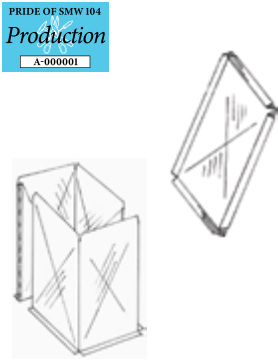
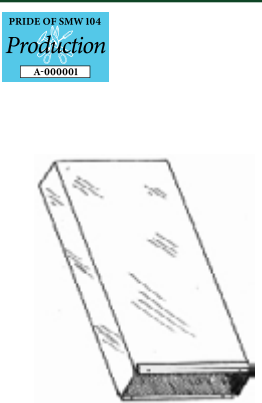

Phone (408) 275-6370
 Fax (408) 881-0177
 sales@acostamfg.com
 www.acostamfg.com

<p>Furnace Pipe (Stitch Welded)</p> 	<p>Size Item #</p> <p style="text-align: center;"><i>316 2B Stainless Steel 24 Gauge</i></p> <p>4' Long</p> <p>4"114-2104</p> <p>6"114-2106</p> <p>8"114-2108</p> <p>10"114-2110</p> <p>12"114-2112</p> <p>14"114-2114</p>
<p>Plenum and Cap</p> 	<p>Size Item #</p> <p style="text-align: center;"><i>Galvanized Steel 26 Gauge</i></p> <p>13.5" x 20" x 35.5" & 0.5" Flange.....PM13520</p> <p>16.5" x 20" x 35.5" & 0.5" Flange.....PM16520</p> <p>19.75" x 20" x 35.5" & 0.5" Flange.....PM197520</p>
<p>Riser Pipe</p> 	<p>Size Item #</p> <p style="text-align: center;"><i>Galvanized Steel 26 Gauge</i></p> <p>5' Long</p> <p>3.25"x10"210-1010</p> <p>3.25"x12"210-1012</p> <p>3.25"x14"210-1014</p> <p>• Available in special order sizes, lengths, and gauges.</p>

Phone (408) 275-6370
 Fax (408) 881-0177
 sales@acostamfg.com
 www.acostamfg.com



Spiral Pipe	Size	Item #			
		Galvanized Steel 10' Long	"Visqueen" 10' Long	8' Long	"Visqueen" 8' Long
	26 Gauge				
	3"	125-1203			
	4"	125-1204	125-5204		
	5"	125-1205			
	6"	125-1206	125-5206	125-1606	125-5006
	7"	125-1207			
	8"	125-1208	125-5208	125-1608	125-5008
	9"	125-1209			
	10"	125-1210	125-5210	125-1610	125-5010
	12"	125-1212	125-5212	125-1612	125-5012
	14"	125-1214	125-5214	125-1614	125-5014
	24 Gauge				
	4"	125-1304			
	6"	125-1306			
	8"	125-1308			
	10"	125-1310			
	12"	125-1312			
	14"	125-1314			
	16"	125-1316	125-5316	125-1716	125-5016
	18"	125-1318	125-5318	125-1718	125-5018
	20"	125-1320	125-5320	125-1720	125-5020
	22"	125-1322	125-5322		
	24"	125-1324	125-5324		
	26"	125-1326	125-5326		
	22 Gauge				
	28"	125-1428	125-5428		
	30"	125-1430	125-5430		
	32"	125-1432	125-5432		
	34"	125-1434	125-5434		
	36"	125-1436	125-5436		
Sizes from 38"-64" are made-to-order.					
20' lengths are made-to-order.					

Yes We Can!



Phone (408) 275-6370
 Fax (408) 881-0177
 sales@acostamfg.com
 www.acostamfg.com

Spiral Pipe	Size	Item #
 	<p>304 2B Stainless Steel</p> <p><i>10' Long</i> <i>24 Gauge</i></p> <p>3".....125-2203 4".....125-2204 6".....125-2206.....125-5506 8".....125-2208.....125-5508 10".....125-2210.....125-5510 12".....125-2212.....125-5512 14".....125-2214.....125-5514 16".....125-2316 18".....125-2318</p> <p>Made to Order: • 316 2B Stainless Steel (3"-64") • 304 2B Stainless Steel (20"-64")</p>	<p>0.025 Aluminum</p>





Yes We Can!

Acosta

Sheet Metal Manufacturing, Inc.



Phone (408) 275-6370
 Fax (408) 881-0177
 sales@acostamfg.com
 www.acostamfg.com

Wire Flex (without Collars)	Size	Item #			
 		4.2 R-Value	6 R-Value (Silver Jacket Only)		
	25' Long	4".....	110-2204.....	110-2504	
	5".....	110-2205.....	110-2505	110-2505	
	6".....	110-2206.....	110-2506	110-2506	
	7".....	110-2207.....	110-2507	110-2507	
	8".....	110-2208.....	110-2508	110-2508	
	9".....	110-2209.....	110-2509	110-2509	
	10".....	110-2210.....	110-2510	110-2510	
	12".....	110-2212.....	110-2512	110-2512	
	14".....	110-2214.....	110-2514	110-2514	
	16".....	110-2216.....	110-2516	110-2516	
	18".....	110-2218.....	110-2518	110-2518	
	20".....	110-2220.....	110-2520	110-2520	
			<ul style="list-style-type: none"> • 10" water column 		
	Wire Flex (with Collars)	Size	Item #		
  		4.2 R-Value	8 R-Value (Silver Jacket Only)	4.2 R-Value with damper	
	5' Long	4".....	110-2004.....	110-3804	
	5".....	110-2005.....	110-3805	110-3805	
	6".....	110-2006.....	110-3806.....	110-3806.....	110-2306
	7".....	110-2007.....	110-3807	110-3807	
	8".....	110-2008.....	110-3808.....	110-3808.....	110-2308
	9".....	110-2009.....	110-3809	110-3809	
	10".....	110-2010.....	110-3810.....	110-3810.....	110-2310
	12".....	110-2012.....	110-3812.....	110-3812.....	110-2312
	14".....	110-2014.....	110-3814.....	110-3814.....	110-2314
	16".....	110-2016.....	110-3816.....	110-3816.....	110-2316
	18".....	110-2018.....	110-3818.....	110-3818.....	110-2318
	20".....	110-2020.....	110-3820.....	110-3820.....	110-2320
			<ul style="list-style-type: none"> • Collars taped with 555 U.L. Duct tape • 10" water column 		

This page intentionally left blank

SPIRAL PRODUCTS

Assorted Spiral Pipe and accessories







Yes We Can!

Acosta

Sheet Metal Manufacturing, Inc.



Phone (408) 275-6370
 Fax (408) 881-0177
 sales@acostamfg.com
 www.acostamfg.com

Spiral Elbow 45 Degree	Size	Item #	
 		<i>Short Radius</i>	<i>Long Radius</i>
 		Short Radius	Long Radius

24 Gauge

6".....	152-1206.....	154-1206
8".....	152-1208.....	154-1208
10".....	152-1210.....	154-1210
12".....	152-1212.....	154-1212
14".....	152-1214.....	154-1214
16".....	152-1316.....	154-1316
18".....	152-1318.....	154-1318
20".....	152-1320.....	154-1320
22".....	152-1322.....	154-1322
24".....	152-1324.....	154-1324

24 Gauge

6".....	153-1206.....	155-1206
8".....	153-1208.....	155-1208
10".....	153-1210.....	155-1210
12".....	153-1212.....	155-1212
14".....	153-1214.....	155-1214
16".....	153-1316.....	155-1316
18".....	153-1318.....	155-1318
20".....	153-1320.....	155-1320
22".....	153-1322.....	155-1322
24".....	153-1324.....	155-1324

Yes We Can!



Phone (408) 275-6370
 Fax (408) 881-0177
 sales@acostamfg.com
 www.acostamfg.com

Spiral Collar	Size	Item #			
		Galvanized	304 2B Stainless	0.025 Aluminum	
	26 Gauge				
	3"	180-3003	180-3103		
	4"	180-3004	180-3104		
	5"	180-3005			
	6"	180-3006	180-3106	180-3206	
	7"	180-3007			
	8"	180-3008	180-3108	180-3208	
	9"	180-3009			
	10"	180-3010	180-3110	180-3210	
	12"	180-3012	180-3112	180-3212	
	14"	180-3014	180-3114	180-3214	
	24 Gauge				
	16"	180-3016	180-3116		
	18"	180-3018	180-3118		
	20"	180-3020			
	22"	180-3022			
	24"	180-3024			
	26"	180-3026			
	22 Gauge				
	28"	180-3028			
	30"	180-3030			
	32"	180-3032			
	34"	180-3034			
	36"	180-3036			
	<p>Sizes from 38"-64" are available upon request.</p>				

• 10" water column



Yes We Can!

Acosta

Sheet Metal Manufacturing, Inc.

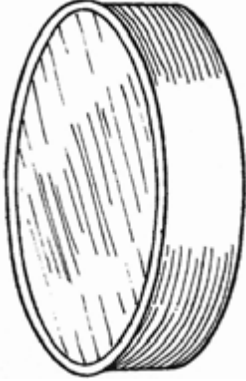

Phone (408) 275-6370
 Fax (408) 881-0177
 sales@acostamfg.com
 www.acostamfg.com

Spiral End Cap	Size	Item #	
 	<i>26 Gauge</i>		
	4".....	185-1104	
	5".....	185-1105	
	6".....	185-1106	
	7".....	185-1107	
	8".....	185-1108	
	9".....	185-1109	
	10".....	185-1110	
	12".....	185-1112	
	14".....	185-1114	
	<i>24 Gauge</i>		
	16".....	185-1116	
	18".....	185-1118	
	20".....	185-1120	
	22".....	185-1122	
	24".....	185-1124	
	26".....	185-1126	
	Spiral Taper with Collar	Size	Item #
	 	<i>24 Gauge</i>	<i>24 Gauge</i>
		6-4".....	190-2144
8-4".....		190-2147	18-16".....190-2166
8-6".....		190-2146	20-16".....190-2169
10-6".....		190-2159	20-18".....190-2168
10-8".....		190-2158	22-18".....190-2196
12-8".....		190-2161	22-20".....190-2194
12-10".....		190-2160	24-20".....190-2192
14-10".....		190-2173	24-22".....190-2190
14-12".....		190-2172	
16-12".....		190-2186	
16-14".....		190-2184	
<ul style="list-style-type: none"> • 3" wide collars, 6" long body 			



Yes We Can!

Acosta

Sheet Metal Manufacturing, Inc.

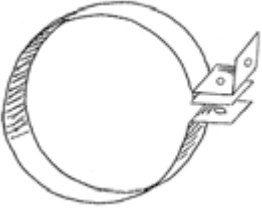

Phone (408) 275-6370
 Fax (408) 881-0177
 sales@acostamfg.com
 www.acostamfg.com

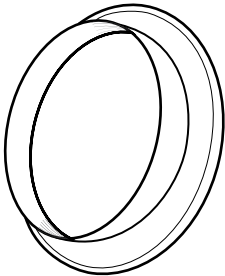
Hanger Strap	Size	Item #
  	1-Piece	
	<p><i>16 Gauge</i></p> <p>6" 290-1606</p> <p>8" 290-1608</p> <p>10" 290-1610</p> <p>12" 290-1612</p> <p>14" 290-1614</p> <p>16" 290-1616</p> <p>18" 290-1618</p> <p>20" 290-1620</p> <p>22" 290-1622</p> <p>24" 290-1624</p>	
2-Piece		
<p><i>16 Gauge*</i></p> <p>16" 290-1716</p> <p>18" 290-1718</p> <p>20" 290-1720</p> <p>22" 290-1722</p> <p>24" 290-1724</p>		
Duraflange	Size	Item #
	<i>16 Gauge</i>	
	6" 181-5006	
	8" 181-5008	
	10" 181-5010	
	12" 181-5012	
	14" 181-5014	
	16" 181-5016	
	18" 181-5018	
	20" 181-5020	
	22" 181-5022	24" 181-5024

Phone (408) 275-6370
 Fax (408) 881-0177
 sales@acostamfg.com
 www.acostamfg.com



Yes We Can!

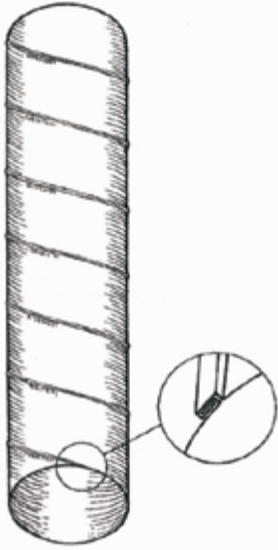

Spiral Pipe	Size	Item #			
		Galvanized Steel 10' Long	"Visqueen" 10' Long	8' Long	"Visqueen" 8' Long
 	26 Gauge				
	3".....	125-1203			
	4".....	125-1204.....	125-5204		
	5".....	125-1205			
	6".....	125-1206.....	125-5206.....	125-1606.....	125-5006
	7".....	125-1207			
	8".....	125-1208.....	125-5208.....	125-1608.....	125-5008
	9".....	125-1209			
	10".....	125-1210.....	125-5210.....	125-1610.....	125-5010
	12".....	125-1212.....	125-5212.....	125-1612.....	125-5012
	14".....	125-1214.....	125-5214.....	125-1614.....	125-5014
	24 Gauge				
	4".....	125-1304			
	6".....	125-1306			
	8".....	125-1308			
	10".....	125-1310			
	12".....	125-1312			
	14".....	125-1314			
	16".....	125-1316.....	125-5316.....	125-1716.....	125-5016
	18".....	125-1318.....	125-5318.....	125-1718.....	125-5018
	20".....	125-1320.....	125-5320.....	125-1720.....	125-5020
	22".....	125-1322.....	125-5322		
	24".....	125-1324.....	125-5324		
	26".....	125-1326.....	125-5326		
	22 Gauge				
	28".....	125-1428.....	125-5428		
	30".....	125-1430.....	125-5430		
	32".....	125-1432.....	125-5432		
	34".....	125-1434.....	125-5434		
	36".....	125-1436.....	125-5436		
	Sizes from 38"-64" are made-to-order.				
	20' lengths are made-to-order.				

Phone (408) 275-6370
 Fax (408) 881-0177
 sales@acostamfg.com
 www.acostamfg.com

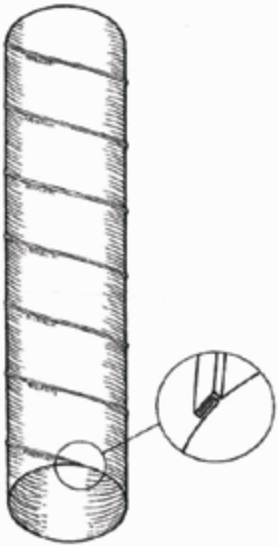

Spiral Pipe	Size	Item #
  	304 2B Stainless Steel	0.025 Aluminum
	10' Long	
	24 Gauge	
	3".....	125-2203
	4".....	125-2204
	6".....	125-2206.....125-5506
	8".....	125-2208.....125-5508
	10".....	125-2210.....125-5510
	12".....	125-2212.....125-5512
	14".....	125-2214.....125-5514
	16".....	125-2316
	18".....	125-2318
	Made to Order:	
	• 316 2B Stainless Steel (3"–64")	
	• 304 2B Stainless Steel (20"–64")	

Yes We Can!

Acosta

Sheet Metal Manufacturing, Inc.



Phone (408) 275-6370
 Fax (408) 881-0177
 sales@acostamfg.com
 www.acostamfg.com

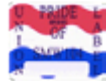

Spiral-Helix Ovalizer Chart

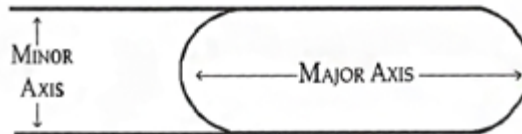

Minor Axis Size of Oval Spiral Pipe

Round Spiral Pipe Circumference

	6"	8"	10"	12"	14"	16"	18"	20"	22"	24"
14"	18.8	17.7								
16"	22.0	20.9	19.8	18.6						
18"	25.1	24.1	22.9	21.8	20.6					
20"	28.3	27.2	26.1	24.9	23.8	22.7				
22"	31.5	30.4	29.3	28.1	27.0	25.8	24.7			
24"	34.6	33.6	32.4	31.3	30.1	29.0	27.9	26.7		
26"	37.8	36.7	35.6	34.4	33.3	32.2	31.0	29.9	28.7	
28"	40.9	39.9	38.7	37.6	36.5	35.3	34.2	33.0	31.9	30.7
30"	44.1	43.0	41.9	40.8	39.6	38.5	37.3	36.2	35.1	33.9
32"	47.3	46.2	45.1	43.9	42.8	41.6	40.5	39.4	38.2	37.1
34"	50.4	49.4	48.2	47.1	46.0	44.8	43.7	42.5	41.4	40.2
36"	53.6	52.5	51.4	50.3	49.1	48.0	46.8	45.7	44.5	43.4
38"	56.8	55.7	54.6	53.4	52.3	51.1	50.0	48.5	47.7	46.6
40"	59.9	58.9	57.7	56.6	55.4	54.3	53.2	52.0	50.9	49.7
42"	63.1	62.0	60.9	59.7	58.6	57.5	56.3	55.2	54.0	52.9

Final Measurement of Major Axis (in inches)

Yes We Can!

Acosta

Sheet Metal Manufacturing, Inc.



Phone (408) 275-6370
 Fax (408) 881-0177
 sales@acostamfg.com
 www.acostamfg.com

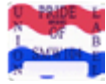

Spiral-Helix Ovalizer Chart

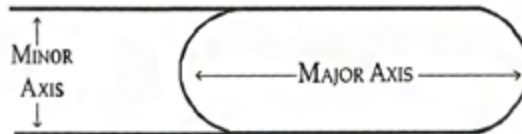

Minor Axis Size of Oval Spiral Pipe

	6"	8"	10"	12"	14"	16"	18"	20"	22"	24"
44"	66.3	65.2	64.1	62.9	61.8	60.6	59.5	58.3	57.2	56.1
46"	71.4	68.3	67.2	66.1	64.9	63.8	62.7	61.5	60.4	59.2
48"	72.6	71.5	70.4	69.2	68.1	67.0	65.8	64.7	63.5	62.4
50"	75.7	74.7	73.5	72.4	71.3	70.1	69.0	67.8	66.7	65.6
52"	78.9	77.8	76.7	75.6	74.4	73.3	72.1	70.9	69.9	68.7
54"	82.1	81.0	79.9	78.7	77.6	76.5	75.3	74.2	73.0	71.9
56"	85.2	84.2	83.0	81.9	80.7	79.6	78.5	77.3	76.2	75.0
58"			86.2	85.1	83.9	82.8	81.6	80.5	79.3	78.2
60"					87.1	85.9	84.8	83.7	82.5	81.4
62"	Final Measurement of Major Axis (in inches)					89.1	88.0	86.8	85.7	84.5
64"							91.1	90.0	88.8	87.7

Round Spiral Pipe Circumference

This page intentionally left blank

ELBOWS PRODUCTS

Assorted elbows for commercial and residential needs



Phone (408) 275-6370
 Fax (408) 881-0177
 sales@acostamfg.com
 www.acostamfg.com

Yes We Can!

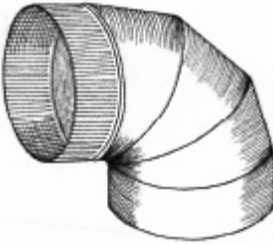

Adjustable Elbow 90 Degree	Size	Item #			
		<i>Galvanized 26 Gauge</i>	<i>Galvanized 24 Gauge</i>	<i>Galvanized 22 Gauge</i>	<i>304 2B Stainless 26 Gauge</i>
	3"	131-1203			131-2203
	4"	131-1204	131-1304		131-2204
	5"	131-1205	131-1305		131-2205
	6"	131-1206	131-1306		131-2206
	7"	131-1207	131-1307		131-2207
	8"	131-1208	131-1308		131-2208
	9"	131-1209	131-1309		131-2209
	10"	131-1210	131-1310		131-2210
	12"	131-1212	131-1312		131-2212
	14"	131-1214	131-1314		131-2214
	16"		131-1316		(24 gauge) 131-2216
	18"		131-1318		
	20"		131-1320		
	22"		131-1322		
	24"		131-1324		
	26"		131-1326		
	28"			131-1428	
	30"			131-1430	
	32"			131-1432	
	34"			131-1434	
			<i>0.025 Aluminum</i>	<i>316 2B Stainless 24 Gauge</i>	
		3"	131-5203		131-2303
		4"	131-5204		131-2304
		5"	131-5205		131-2305
		6"	131-5206		131-2306
		7"	131-5207		131-2307
		8"	131-5208		131-2308
		9"	131-5209		131-2309
		10"	131-5210		131-2310
		12"	131-5212		131-2312
		14"	131-5214		131-2314

• *Riveted construction with uniform crimping at one end.*

Yes We Can!

Acosta

Sheet Metal Manufacturing, Inc.

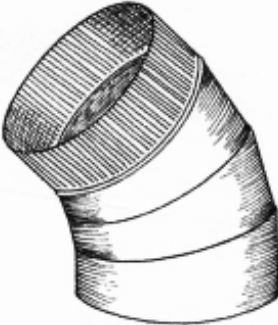

Phone (408) 275-6370
 Fax (408) 881-0177
 sales@acostamfg.com
 www.acostamfg.com

Adjustable Elbow 45 Degree	Size	Item #			
		<i>Galvanized</i> 26 Gauge	<i>Galvanized</i> 24 Gauge	<i>Galvanized</i> 22 Gauge	304 2B Stainless 26 Gauge
 	3"	130-1203			130-2203
	4"	130-1204	130-1304		130-2204
	5"	130-1205	130-1305		130-2205
	6"	130-1206	130-1306		130-2206
	7"	130-1207	130-1307		130-2207
	8"	130-1208	130-1308		130-2208
	9"	130-1209	130-1309		130-2209
	10"	130-1210	130-1310		130-2210
	12"	130-1212	130-1312		130-2212
	14"	130-1214	130-1314		130-2214
	16"		130-1316	(24 gauge)	130-2216
	18"		130-1318		
	20"		130-1320		
	22"		130-1322		
	24"		130-1324		
	26"		130-1326		
	28"				130-1428
	30"				130-1430
	32"				130-1432
	34"				130-1434
			0.025 Aluminum	316 2B Stainless 24 Gauge	
		3"	130-5203		130-2303
		4"	130-5204		130-2304
		5"	130-5205		130-2305
		6"	130-5206		130-2306
		7"	130-5207		130-2307
		8"	130-5208		130-2308
		9"	130-5209		130-2309
	10"	130-5210		130-2310	
	12"	130-5212		130-2312	
	14"	130-5214		130-2314	

- Riveted construction with uniform crimping at one end.*

Yes We Can!

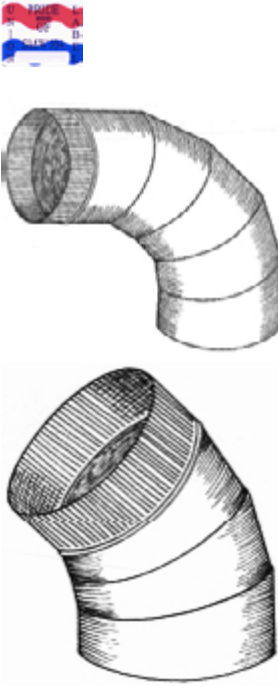
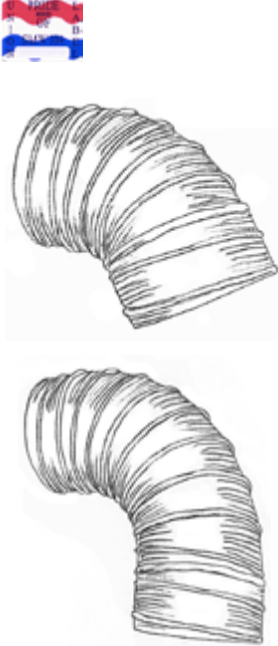

Phone (408) 275-6370
 Fax (408) 881-0177
 sales@acostamfg.com
 www.acostamfg.com

Long Radius Adjustable Elbow	Size	Item #			
		45 Degree	90 Degree		
	<p>24 Gauge</p> <p>4".....132-1304.....133-1304</p> <p>6".....132-1306.....133-1306</p> <p>8".....132-1308.....133-1308</p> <p>10".....132-1310.....133-1310</p> <p>12".....132-1312.....133-1312</p> <p>14".....132-1314.....133-1314</p> <p>16".....132-1316.....133-1316</p> <p>18".....132-1318.....133-1318</p> <p>• Riveted construction with uniform crimping at one end.</p>				
Spiral Elbow	Size	Item #			
		45 Degree Short Radius	90 Degree Short Radius	45 Degree Long Radius	90 Degree Long Radius
	<p>24 Gauge</p> <p>6".....152-1206.....153-1206.....154-1206.....155-1206</p> <p>8".....152-1208.....153-1208.....154-1208.....155-1208</p> <p>10".....152-1210.....153-1210.....154-1210.....155-1210</p> <p>12".....152-1212.....153-1212.....154-1212.....155-1212</p> <p>14".....152-1214.....153-1214.....154-1214.....155-1214</p> <p>16".....152-1316.....153-1316.....154-1316.....155-1316</p> <p>18".....152-1318.....153-1318.....154-1318.....155-1318</p> <p>20".....152-1320.....153-1320.....154-1320.....155-1320</p> <p>22".....152-1322.....153-1322.....154-1322.....155-1322</p> <p>24".....152-1324.....153-1324.....154-1324.....155-1324</p>				

Yes We Can!

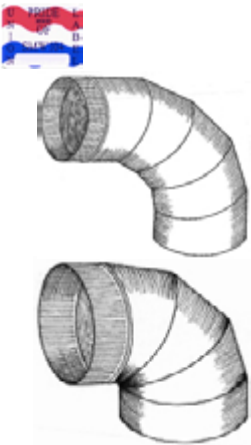
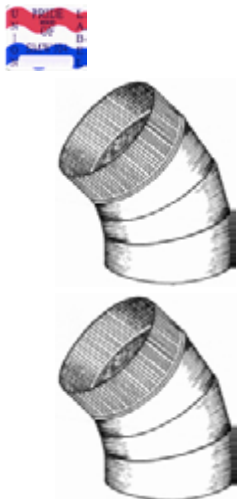
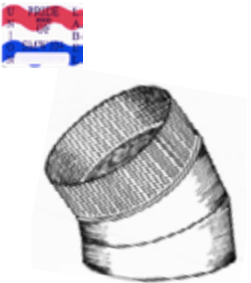

Phone (408) 275-6370
 Fax (408) 881-0177
 sales@acostamfg.com
 www.acostamfg.com

Spot and Sealed Elbow 90 Degree	Size	Item #		
		Short Radius	Long Radius	
	24 Gauge	4".....	140-1304.....	151-1304
	6".....	140-1306.....	151-1306	
	8".....	140-1308.....	151-1308	
	10".....	140-1310.....	151-1310	
	12".....	140-1312.....	151-1312	
	14".....	140-1314.....	151-1314	
	16".....	140-1316.....	151-1416	
	18".....	140-1318.....	151-1418	
	20".....	140-1320		
		<ul style="list-style-type: none"> • Spot-welded construction with uniform Small End/Small End. 		
	Spot and Sealed Elbow 45 Degree	Size	Item #	
			Short Radius	Long Radius
24 Gauge		4".....	141-1304.....	150-1304
6".....		141-1306.....	150-1306	
8".....		141-1308.....	150-1308	
10".....		141-1310.....	150-1310	
12".....		141-1312.....	150-1312	
14".....		141-1314.....	150-1314	
16".....		141-1316.....	150-1416	
18".....		141-1318.....	150-1418	
20".....		141-1320		
		<ul style="list-style-type: none"> • Spot-welded construction with uniform Small End/Small End. 		
Spot and Sealed Elbow 22.5 Degree	Size	Item #		
		Short Radius		
	24 Gauge	8".....	142-1308	
	10".....	142-1310		
	12".....	142-1312		
	14".....	142-1314		
	16".....	142-1316		
	<ul style="list-style-type: none"> • Spot-welded construction with uniform Small End/Small End. 			

This page intentionally left blank

WYES&TEES

Wyes and tees for commercial and residential needs





Yes We Can!

Acosta

Sheet Metal Manufacturing, Inc.

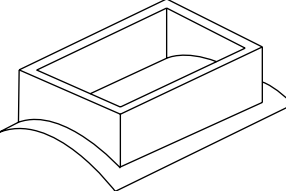

Phone (408) 275-6370
 Fax (408) 881-0177
 sales@acostamfg.com
 www.acostamfg.com

Conical Tap	Size	Item #
	24 Gauge	
	6".....	166-2006
	8".....	166-2008
	10".....	166-2010
	12".....	166-2012
	14".....	166-2014
	16".....	166-2016
	Saddle Tap (Rectangular)	Size
	24 Gauge	
	8"x 16" on 10" round.....	166-3010
	8"x 16" on 12" round.....	166-3012
	8"x 16" on 14" round.....	166-3014
	8"x 12" on 10" round.....	166-3110
	8"x 12" on 12" round.....	166-3112
	8"x 12" on 14" round.....	166-3114
Self Stick Collar	Size	Item #
	26 Gauge	
	4".....	180-4104
	6".....	180-4106
	8".....	180-4108
	10".....	180-4110
	12".....	180-4112
	14".....	180-4114
	24 Gauge	
	16".....	180-4116
	18".....	180-4118
	20".....	180-4120
	22".....	180-4122
	24".....	180-4124

Yes We Can!

Acosta

Sheet Metal Manufacturing, Inc.

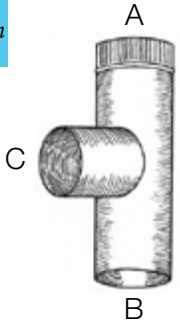
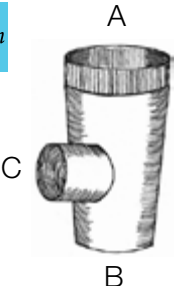

Phone (408) 275-6370
 Fax (408) 881-0177
 sales@acostamfg.com
 www.acostamfg.com

Saddle Tee	Size	Item #
	24 Gauge	
	6" on 8".....	166-1106
	6" on 10".....	166-1108
	6" on 12".....	166-1110
	8" on 10".....	166-1112
	8" on 12".....	166-1114
	8" on 14".....	166-1116
	10" on 12".....	166-1118
	10" on 14".....	166-1120
	10" on 16".....	166-1122
	12" on 14".....	166-1124
	12" on 16".....	166-1126
	12" on 18".....	166-1128
	14" on 16".....	166-1130
	14" on 18".....	166-1132
14" on 20".....	166-1134	
	• Sealed with DP1010 sealant	
Tee	Size	Item #
	26 Gauge	
	A x B x C	
	4x4x4".....	165-0010
	6x6x6".....	165-0020
	8x8x8".....	165-0040
10x10x10".....	165-0060	
	• Sealed with DP1010 sealant	
Vent Tee	Size	Item #
	26 Gauge	
	A x B x C	
	5x4x3".....	165-9010
	6x4x3".....	165-9020
	6x4x4".....	165-9022
	6x5x3".....	165-9025
6x5x4".....	165-9030	
	• Sealed with DP1010 sealant	

Yes We Can!

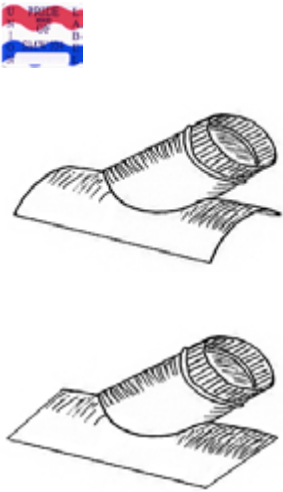
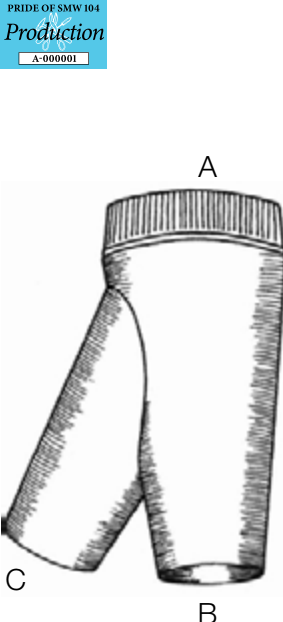

Phone (408) 275-6370
 Fax (408) 881-0177
 sales@acostamfg.com
 www.acostamfg.com

Saddle Wye	Size	Item #	
		<i>Round</i>	<i>Flat</i>
	<p>24 Gauge</p> <p>4" on 6" x 8".....166-1004.....166-1204</p> <p>6" on 8" x 10.....166-1006.....166-1206</p> <p>8" on 10" x 12".....166-1008.....166-1208</p> <p>10" on 12" x 14".....166-1010.....166-1210</p> <p>12" on 14" x 16".....166-1012.....166-1212</p> <p>14" on 16" x 18".....166-1014</p> <p>• Sealed with DP1010 sealant</p>		
Vent Wye	Size	Item #	
			
	<p>26 Gauge</p> <p>A x B x C</p> <p>5x4x3".....160-9020</p> <p>5x4x4".....160-9025</p> <p>6x4x3".....160-9030</p> <p>6x5x3".....160-9035</p> <p>6x5x4".....160-9040</p> <p>• Sealed with DP1010 sealant</p>		

Phone (408) 275-6370
 Fax (408) 881-0177
 sales@acostamfg.com
 www.acostamfg.com

Yes We Can!

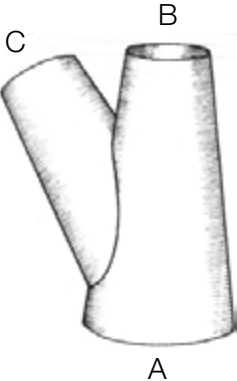

Stock Wye Branches	Size	Item #	Item #
	A x B x C 26 Gauge		A x B x C 26 Gauge
	6x4x4.....160-0105 6x6x4.....160-0110 8x6x4.....160-0205 8x6x6.....160-0210 8x8x4.....160-0215 8x8x6.....160-0220 10x6x6.....160-0305 10x8x4.....160-0310 10x8x6.....160-0315 10x8x8.....160-0320 10x10x4.....160-0325 10x10x6.....160-0330 10x10x8.....160-0335 4x4x4.....160-0005 6x6x6.....160-0115 8x8x8.....160-0225 10x10x10.....160-0340 12x12x10.....160-0450 12x12x12.....160-0455 12x8x8.....160-0410 12x10x4.....160-0415 12x10x6.....160-0420 12x10x8.....160-0425 12x10x10.....160-0430 12x12x4.....160-0435 12x12x6.....160-0440 12x12x8.....160-0445 14x10x8.....160-0515 14x10x10.....160-0520 14x12x6.....160-0525 14x12x8.....160-0530	14x12x10.....160-0535 14x12x12.....160-0540 14x14x6.....160-0545 14x14x8.....160-0550 14x14x10.....160-0555 14x14x12.....160-0560 14x14x14.....160-0565 24 Gauge 16x12x10.....160-0620 16x12x12.....160-0625 16x14x8.....160-0630 16x14x10.....160-0635 16x14x12.....160-0640 16x14x14.....160-0645 16x16x8.....160-0615 16x16x12.....160-0650 16x16x14.....160-0655 18x14x12.....160-0720 18x14x14.....160-0725 18x16x10.....160-0730 18x16x12.....160-0735 18x16x14.....160-0740 18x16x16.....160-0741 20x14x14.....160-0830 20x16x14.....160-0835 20x16x16.....160-0840 20x18x14.....160-0845 20x18x16.....160-0850	
	<ul style="list-style-type: none"> • Sealed with DP1010 sealant 		

This page intentionally left blank

HVAC FITTINGS & ACCESSORIES

Fittings and pipe accessories for commercial and residential needs



Yes We Can!



Phone (408) 275-6370
 Fax (408) 881-0177
 sales@acostamfg.com
 www.acostamfg.com

Ceiling Box	Size	Item #
<div data-bbox="110 499 219 577" style="border: 1px solid black; padding: 2px;"> PRIDE OF SMW 104 Production A-000001 </div> <div data-bbox="126 829 373 1050"> </div> <div data-bbox="126 1134 373 1354"> </div>	<p>A x B x C</p> <p>28 Gauge</p> <p>4x8x4".....215-0504</p> <p>4x10x4".....215-0514</p> <p>6x6x6".....215-1016</p> <p>6x10x6".....215-0526</p> <p>6x12x6".....215-0536</p> <p>6x12x8".....215-0538</p> <p>6x14x6".....215-0546</p> <p>6x14x8".....215-0548</p> <p>8x8x6".....215-1026</p> <p>8x8x8".....215-1028</p> <p>8x10x8".....215-0558</p> <p>8x12x8".....215-0568</p> <p>8x14x8".....215-0578</p> <p>10x10x8".....215-1038</p> <p>10x10x10".....215-1030</p> <p>12x12x10".....215-1040</p> <p>12x12x12".....215-1042</p> <p>14x14x12".....215-1052</p> <p>14x14x14".....215-1054</p> <p>16x16x14".....215-1064</p> <p>26 Gauge</p> <p>14.25x20.25x12".....215-1522</p> <p>14.25x20.25x14".....215-1524</p> <p>14.25x24.25x12".....215-1532</p> <p>14.25x24.25x14".....215-1534</p> <p>14.25x24.25x16".....215-1536</p> <p>14.25x25.25x14".....215-1544</p> <p>14.25x25.25x16".....215-1546</p> <p>24 Gauge</p> <p>18x18x16".....215-1610</p> <p>20x20x18".....215-1620</p> <p>22x22x20".....215-1630</p> <p>• Sealed with DP1010 Sealant</p>	



Yes We Can!

Acosta

Sheet Metal Manufacturing, Inc.

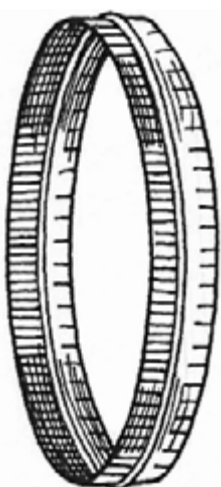

Phone (408) 275-6370
 Fax (408) 881-0177
 sales@acostamfg.com
 www.acostamfg.com

Collar	Size	Item #			
 <p>PRIDE OF SMW 104 Production A-000001</p>		<i>DT/Raw</i>	<i>DT/Crimp</i>	<i>Spin/Raw</i>	<i>Spin/Crimp</i>
	4".....	180-1204.....	180-1304.....	180-1404.....	180-1504
	5".....	180-1205.....	180-1305.....	180-1405.....	180-1505
	6".....	180-1206.....	180-1306.....	180-1406.....	180-1506
	7".....	180-1207.....	180-1307.....	180-1407.....	180-1507
	8".....	180-1208.....	180-1308.....	180-1408.....	180-1508
	10".....	180-1210.....	180-1310.....	180-1410.....	180-1510
	12".....	180-1212.....	180-1312.....	180-1412.....	180-1512
	14".....	180-1214.....	180-1314.....	180-1414.....	180-1514
	16".....	180-1216.....	180-1316.....	180-1416.....	180-1516
	18".....	180-1218.....	180-1318.....	180-1418.....	180-1518
	20".....	180-1220.....	180-1320.....	180-1420.....	180-1520
	22".....	180-1222.....	180-1322.....	180-1422.....	180-1522
	24".....	180-1224.....	180-1324.....	180-1424.....	180-1524
Self Stick Collar	Size	Item #			
 <p>PRIDE OF SMW 104 Production A-000001</p>		<i>26 Gauge</i>			
	4".....	180-4104			
	6".....	180-4106			
	8".....	180-4108			
	10".....	180-4110			
	12".....	180-4112			
		<i>24 Gauge</i>			
	14".....	180-4114			
	16".....	180-4116			
	18".....	180-4118			
	20".....	180-4120			
	22".....	180-4122			
	24".....	180-4124			



Yes We Can!

Acosta

Sheet Metal Manufacturing, Inc.

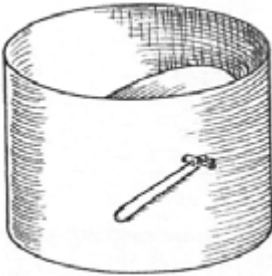

Phone (408) 275-6370
 Fax (408) 881-0177
 sales@acostamfg.com
 www.acostamfg.com

Collar with Damper	Size	Item #		
		<i>"Jiffy" Hardware</i>	<i>Heavy-duty Hardware</i>	
	4"	180-4004		
	5"	180-4005		
	6"	180-4006	180-3906	
	7"	180-4007		
	8"	180-4008	180-3908	
	9"	180-4009		
	10"	180-4010	180-3910	
	12"	180-4012	180-3912	
	14"	180-4014	180-3914	
	16"	180-4016	180-3916	
	18"	180-4018	180-3918	
Damper Blade/Disc	Size	Item #		
		<i>Galvanized Blade</i>	<i>Stainless Steel Blade</i>	
	<i>26 Gauge</i>			
	4"	175-0104	175-0204	
	5"	175-0105		
	6"	175-0106	175-0206	
	7"	175-0107		
	8"	175-0108	175-0208	
	9"	175-0109		
	<i>24 Gauge</i>			
	10"	175-0110		
	12"	175-0112		
	14"	175-0114		
	16"	175-0116		
	18"	175-0118		
	20"	175-0120		
Blast Gate Damper	Size	Item #		
		<i>Galvanized Blade</i>	<i>Stainless Steel Blade</i>	
	2"	175-2002		
	3"	175-2003		
	4"	175-2004	175-2104	
	5"	175-2005		
	6"	175-2006	175-2106	
	8"	175-2008	175-2108	





Yes We Can!

Acosta

Sheet Metal Manufacturing, Inc.



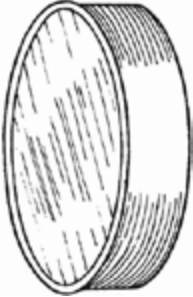
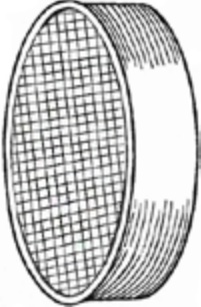

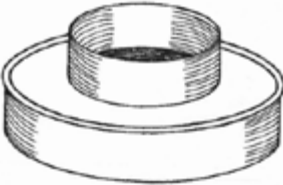
Phone (408) 275-6370
 Fax (408) 881-0177
 sales@acostamfg.com
 www.acostamfg.com

End Cap (Round)	Size	Item #
   	<i>Galvanized</i>	<i>304 2B Stainless Steel</i>
	<i>With 0.25" Mesh</i>	
	26 Gauge	
	3".....	185-1003
	4".....	185-1004.....185-2204
	5".....	185-1005
	6".....	185-1006.....185-2206.....185-1206
	7".....	185-1007
	8".....	185-1008.....185-2208.....185-1208
	9".....	185-1009
	10".....	185-1010.....185-1210
	12".....	185-1012.....185-1212
	14".....	185-1014.....185-1214
	24 Gauge	
	16".....	185-1016
	18".....	185-1018
	20".....	185-1020
	22".....	185-1022
	24".....	185-1024
Reducer	Size	Item #
 	4x3".....	190-3005
	5x3".....	190-3013
	5x4".....	190-3014
	6x3".....	190-3023
	6x4".....	190-3024
	6x5".....	190-3025
	7x6".....	190-3036
	8x6".....	190-3046
	10x8".....	190-3058
	12x8".....	190-3068
	12x10".....	190-3060
	14x12".....	190-3072
	16x14".....	190-3084
	18x16".....	190-3096

Yes We Can!

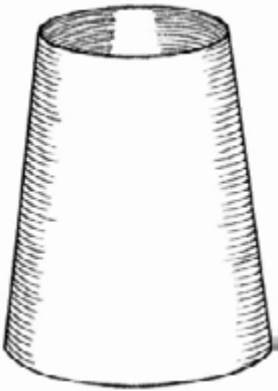

Phone (408) 275-6370
 Fax (408) 881-0177
 sales@acostamfg.com
 www.acostamfg.com

Taper	Size	Item #
 	4-3".....	190-1005
	5-3".....	190-1013
	5-4".....	190-1014
	6-3".....	190-1023
	6-4".....	190-1024
	6-5".....	190-1025
	7"-6".....	190-1036
	8-4".....	190-1044
	8-6".....	190-1046
	8-7".....	190-1047
	10-6".....	190-1056
	10-8".....	190-1058
	10-9".....	190-1059
	12-10".....	190-1060
	12-8".....	190-1068
	14-10".....	190-1070
	14-12".....	190-1072
16-14".....	190-1084	
Taper with Collar	Size	Item #
 	24 Gauge	
	8-6".....	190-2046
	10-8".....	190-2058
	12-10".....	190-2060
	14-10".....	190-2068
	14-12".....	190-2072
	16-14".....	190-2084
	18-16".....	190-2066



Yes We Can!

Acosta

Sheet Metal Manufacturing, Inc.

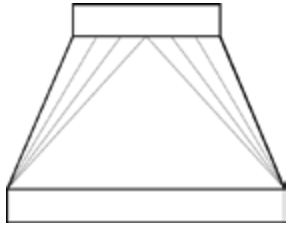

Phone (408) 275-6370
 Fax (408) 881-0177
 sales@acostamfg.com
 www.acostamfg.com

Taper with Collar (for Spiral)	Size	Item #
 	<p><i>24 Gauge</i></p> <p>6-4" 190-2144</p> <p>8-4" 190-2147</p> <p>8-6" 190-2146</p> <p>10-6" 190-2159</p> <p>10-8" 190-2158</p> <p>12-8" 190-2161</p> <p>12-10" 190-2160</p> <p>14-10" 190-2173</p> <p>14-12" 190-2172</p> <p>16-12" 190-2186</p> <p>16-14" 190-2184</p> <p>18-14" 190-2167</p> <p>18-16" 190-2166</p> <p>20-16" 190-2169</p> <p>20-18" 190-2168</p> <p>22-18" 190-2196</p> <p>22-20" 190-2194</p> <p>24-20" 190-2192</p> <p>24-22" 190-2190</p>	
Square to Round	Size	Item #
 	<p><i>24 Gauge</i></p> <p>10x12" to 8" round..... 168-1200</p> <p>10x12" to 10" round..... 168-1210</p> <p>10x12" to 12" round..... 168-1220</p> <p>10x12" to 14" round..... 168-1230</p> <p>12x14" to 8" round..... 168-1400</p> <p>12x14" to 10" round..... 168-1410</p> <p>12.5x14" to 12" round..... 168-1600</p> <p>12.5x14" to 14" round..... 168-1800</p> <p>15x16" to 16" round..... 168-2000</p> <p>15x16" to 18" round..... 168-2200</p> <p>20x17.5" to 16" round..... 168-2400</p> <p>20x17.5" to 18" round..... 168-2600</p>	

Yes We Can!

Acosta

Sheet Metal Manufacturing, Inc.

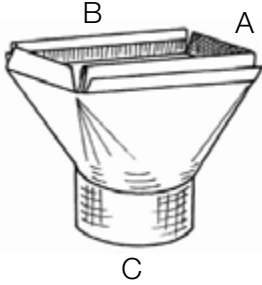
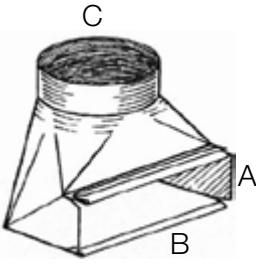
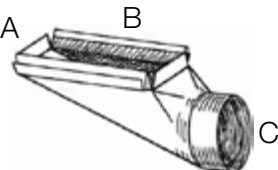

Phone (408) 275-6370
 Fax (408) 881-0177
 sales@acostamfg.com
 www.acostamfg.com

F-5 Straight Boot	Size	Item #
<p>PRIDE OF SMW 104 Production A-000001</p> 	<p>A x B x C 3.25x10x4".....210-5014 3.25x10x6".....210-5016 3.25x10x7".....210-5017 3.25x10x8".....210-5018 3.25x12x6".....210-5026 3.25x12x8".....210-5028 3.25x14x6".....210-5036 3.25x14x8".....210-5038</p> <ul style="list-style-type: none"> Sealed with DP1010 Sealant 	
F-13 Angle Boot 90 Degree	Size	Item #
<p>PRIDE OF SMW 104 Production A-000001</p> 	<p>A x B x C 3.25x10x4".....210-6014 3.25x10x6".....210-6016 3.25x10x8".....210-6018 3.25x12x6".....210-6026 3.25x12x8".....210-6028 3.25x14x6".....210-6036 3.25x14x8".....210-6038</p> <ul style="list-style-type: none"> Sealed with DP1010 Sealant 	
F-17 Cone Boot	Size	Item #
<p>PRIDE OF SMW 104 Production A-000001</p> 	<p>A x B x C 3.25x10x6".....210-7016 3.25x10x8".....210-7018 3.25x12x6".....210-7026 3.25x12x8".....210-7028 3.25x14x6".....210-7036 3.25x14x8".....210-7038</p> <ul style="list-style-type: none"> Sealed with DP1010 Sealant 	

Yes We Can!

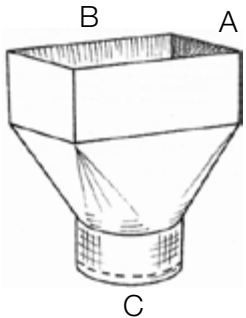
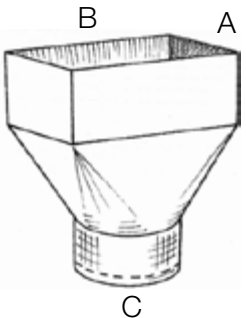

Phone (408) 275-6370
 Fax (408) 881-0177
 sales@acostamfg.com
 www.acostamfg.com

Fan Boot	Size	Item #
<p>PRIDE OF SMW 104 Production A-000001</p> 	<p>A x B x C 3.25x10x6"210-5116 3.25x10x7"210-5117</p> <p>• Sealed with DP1010 Sealant</p>	
PH 1	Size	Item #
<p>PRIDE OF SMW 104 Production A-000001</p> 	<p>A x B x C 2.25x10x4"200-1100 2.25x10x6"200-1102 2.25x12x6"200-1105 2.25x14x6"200-1112 2.25x14x8"200-1114 4x10x4"200-1120 4x10x6"200-1122 4x12x6"200-1132 4x12x8"200-1134 4x14x6"200-1142 4x14x8"200-1144 6x10x6"200-1152 6x12x6"200-1162 6x12x8"200-1164 6x14x8"200-1174</p> <p>• Sealed with DP1010 Sealant</p>	

Yes We Can!

Acosta

Sheet Metal Manufacturing, Inc.

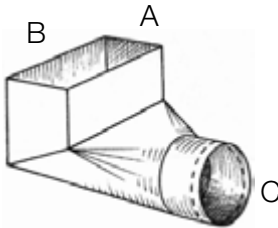
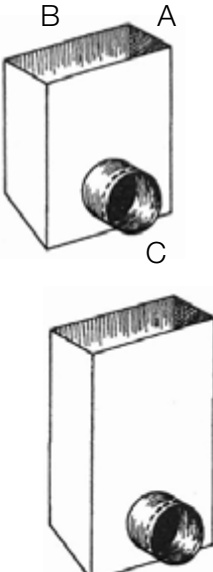

Phone (408) 275-6370
 Fax (408) 881-0177
 sales@acostamfg.com
 www.acostamfg.com

PH 2	Size	Item #
 <p>PRIDE OF SMW 104 Production A-000001</p>	<p>A x B x C</p> <p>2.25x10x4".....200-1200</p> <p>2.25x10x6".....200-1202</p> <p>2.25x12x6".....200-1205</p> <p>2.25x14x6".....200-1212</p> <p>4x10x4".....200-1220</p> <p>4x10x6".....200-1222</p> <p>4x12x6".....200-1232</p> <p>4x12x8".....200-1234</p> <p>4x14x6".....200-1242</p> <p>4x14x8".....200-1244</p> <p>6x10x6".....200-1252</p> <p>6x12x6".....200-1262</p> <p>6x12x8".....200-1264</p> <p>6x14x8".....200-1274</p> <p>8x14x8".....200-1284</p> <p>• Sealed with DP1010 Sealant</p>	
PH 2A	Size	
 <p>PRIDE OF SMW 104 Production A-000001</p>	<p>A x B x C</p> <p>4x10x4".....200-2100</p> <p>4x12x6".....200-2103</p> <p>4x14x6".....200-2042.....200-2142</p> <p>4x14x8".....200-2044.....200-2144</p> <p>6x12x6".....200-2062.....200-2154</p> <p>6x12x8".....200-2160</p> <p>6x14x8".....200-2074.....200-2174</p> <p>8x12x8".....200-2194</p> <p>8x14x8".....200-2084.....200-2184</p> <p>• Sealed with DP1010 Sealant</p>	<p>16" Long</p> <p>24" Long</p>

Yes We Can!

Acosta

Sheet Metal Manufacturing, Inc.



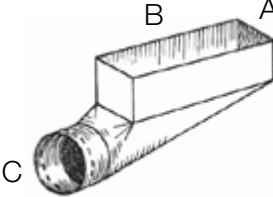
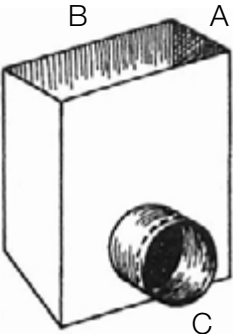

Phone (408) 275-6370
 Fax (408) 881-0177
 sales@acostamfg.com
 www.acostamfg.com

PH 3	Size	Item #
<div data-bbox="110 510 212 575" style="border: 1px solid black; padding: 2px;"> PRIDE OF SMW 104 Production A-000001 </div> 	<p>A x B x C</p> <p>2.25x10x4".....200-1300</p> <p>2.25x12x6".....200-1305</p> <p>2.25x14x6".....200-1312</p> <p>4x10x4".....200-1320</p> <p>4x10x6".....200-1322</p> <p>4x12x6".....200-1332</p> <p>4x12x8".....200-1334</p> <p>4x14x6".....200-1342</p> <p>4x14x8".....200-1344</p> <p>6x10x6".....200-1352</p> <p>6x12x6".....200-1362</p> <p>6x12x8".....200-1364</p> <p>6x14x8".....200-1374</p> <p>• Sealed with DP1010 Sealant</p>	
Perimeter Box	Size	Item #
<div data-bbox="110 1337 212 1402" style="border: 1px solid black; padding: 2px;"> PRIDE OF SMW 104 Production A-000001 </div> 	<p>A x B x C</p> <p>2.25x14x6".....200-3012</p> <p>2.25x14x8".....200-3014</p> <p>4x10x4".....200-3020</p> <p>4x10x6".....200-3022</p> <p>4x12x6".....200-3032</p> <p>4x12x8".....200-3034</p> <p>4x14x6".....200-3042</p> <p>4x14x8".....200-3044</p> <p>6x10x6".....200-3052</p> <p>• Sealed with DP1010 Sealant</p>	

Yes We Can!

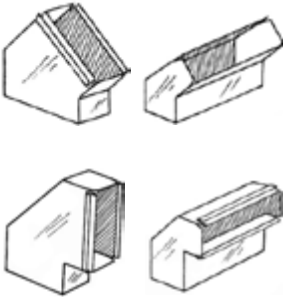
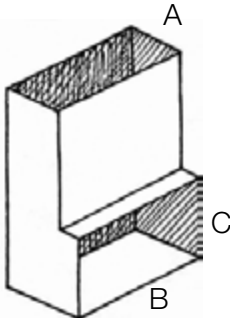

Phone (408) 275-6370
 Fax (408) 881-0177
 sales@acostamfg.com
 www.acostamfg.com

Riser Elbow	Size	Item #																							
 <p>PRIDE OF SMW 104 Production A-000001</p>	<table border="0"> <thead> <tr> <th></th> <th><i>90 Degree Long Way</i></th> <th><i>90 Degree Short Way</i></th> <th><i>45 Degree Long Way</i></th> <th><i>45 Degree Short Way</i></th> </tr> </thead> <tbody> <tr> <td>3.25x10".....</td> <td>210-3110.....</td> <td>210-3010.....</td> <td>210-2110.....</td> <td>210-2010.....</td> </tr> <tr> <td>3.25x12".....</td> <td>210-3112.....</td> <td>210-3012.....</td> <td>210-2112.....</td> <td>210-2012.....</td> </tr> <tr> <td>3.25x14".....</td> <td>210-3114.....</td> <td>210-3014.....</td> <td>210-2114.....</td> <td>210-2014.....</td> </tr> </tbody> </table>		<i>90 Degree Long Way</i>	<i>90 Degree Short Way</i>	<i>45 Degree Long Way</i>	<i>45 Degree Short Way</i>	3.25x10".....	210-3110.....	210-3010.....	210-2110.....	210-2010.....	3.25x12".....	210-3112.....	210-3012.....	210-2112.....	210-2012.....	3.25x14".....	210-3114.....	210-3014.....	210-2114.....	210-2014.....				
	<i>90 Degree Long Way</i>	<i>90 Degree Short Way</i>	<i>45 Degree Long Way</i>	<i>45 Degree Short Way</i>																					
3.25x10".....	210-3110.....	210-3010.....	210-2110.....	210-2010.....																					
3.25x12".....	210-3112.....	210-3012.....	210-2112.....	210-2012.....																					
3.25x14".....	210-3114.....	210-3014.....	210-2114.....	210-2014.....																					
 <p>PRIDE OF SMW 104 Production A-000001</p>	<table border="0"> <thead> <tr> <th>Size</th> <th>Item #</th> </tr> </thead> <tbody> <tr> <td>A x B x C</td> <td></td> </tr> <tr> <td>3.25x10x4".....</td> <td>210-4014</td> </tr> <tr> <td>3.25x10x6".....</td> <td>210-4016</td> </tr> <tr> <td>3.25x12x4".....</td> <td>210-4024</td> </tr> <tr> <td>3.25x12x6".....</td> <td>210-4026</td> </tr> <tr> <td>3.25x14x4".....</td> <td>210-4034</td> </tr> <tr> <td>3.25x14x6".....</td> <td>210-4036</td> </tr> <tr> <td>3.25x14x8".....</td> <td>210-4038</td> </tr> </tbody> </table>	Size	Item #	A x B x C		3.25x10x4".....	210-4014	3.25x10x6".....	210-4016	3.25x12x4".....	210-4024	3.25x12x6".....	210-4026	3.25x14x4".....	210-4034	3.25x14x6".....	210-4036	3.25x14x8".....	210-4038						
Size	Item #																								
A x B x C																									
3.25x10x4".....	210-4014																								
3.25x10x6".....	210-4016																								
3.25x12x4".....	210-4024																								
3.25x12x6".....	210-4026																								
3.25x14x4".....	210-4034																								
3.25x14x6".....	210-4036																								
3.25x14x8".....	210-4038																								
 <p>PRIDE OF SMW 104 Production A-000001</p>	<table border="0"> <thead> <tr> <th>Size</th> <th colspan="2">Item #</th> </tr> <tr> <td></td> <th><i>With Screen and Damper</i></th> <th><i>With Screen and Backdraft Damper</i></th> </tr> </thead> <tbody> <tr> <td><i>Round</i></td> <td></td> <td></td> </tr> <tr> <td>6".....</td> <td>504-0506</td> <td></td> </tr> <tr> <td>8".....</td> <td>504-0508</td> <td></td> </tr> <tr> <td><i>Square</i></td> <td></td> <td></td> </tr> <tr> <td>8"x8".....</td> <td>504-1505.....</td> <td>504-2005</td> </tr> <tr> <td>8"x16".....</td> <td>504-1510.....</td> <td>504-2010</td> </tr> </tbody> </table>	Size	Item #			<i>With Screen and Damper</i>	<i>With Screen and Backdraft Damper</i>	<i>Round</i>			6".....	504-0506		8".....	504-0508		<i>Square</i>			8"x8".....	504-1505.....	504-2005	8"x16".....	504-1510.....	504-2010
Size	Item #																								
	<i>With Screen and Damper</i>	<i>With Screen and Backdraft Damper</i>																							
<i>Round</i>																									
6".....	504-0506																								
8".....	504-0508																								
<i>Square</i>																									
8"x8".....	504-1505.....	504-2005																							
8"x16".....	504-1510.....	504-2010																							





Yes We Can!

Acosta

Sheet Metal Manufacturing, Inc.

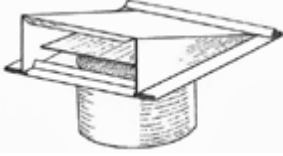
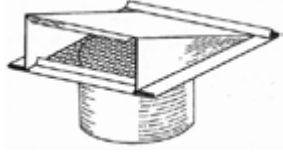







Phone (408) 275-6370
 Fax (408) 881-0177
 sales@acostamfg.com
 www.acostamfg.com

"Old Style" Rain Hood	Size	Item #	
 		<i>With Screen</i>	<i>With Backdraft Damper</i>
	3".....	502-0503.....	502-1003
	4".....	502-0504.....	502-1004
	5".....	502-0505.....	502-1005
	6".....	502-0506.....	502-1006
	7".....	502-0507.....	502-1007
	8".....	502-0508	
	10".....	502-0510	
	3.25"x10" Square		
	(Screen Only).....	502-1505	
Rain Hood (for wood)	Size	Item #	
 		<i>With Screen</i>	<i>With Backdraft Damper</i>
	4".....	503-0604.....	503-1104
	6".....	503-0606.....	503-1106
	8".....	503-0608.....	503-1108
Rain Hood (for stucco)	Size	Item #	
 		<i>With Screen</i>	<i>With Backdraft Damper</i>
	4".....	503-0504.....	503-1004
	6".....	503-0506.....	503-1006
	8".....	503-0508.....	503-1008

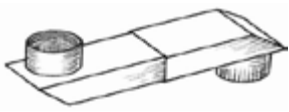
Yes We Can!

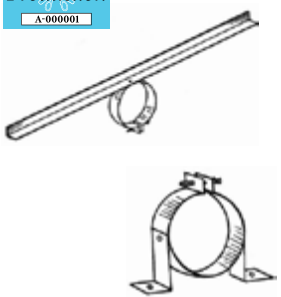

Phone (408) 275-6370
 Fax (408) 881-0177
 sales@acostamfg.com
 www.acostamfg.com

Dryer Vent	Size	Item #		
 	4.....	200-7000		
Dust Cover	Size	Item #		
 	4x10".....	200-3230		
	4x12".....	200-3235		
	4x14".....	200-3240		
	6x10".....	200-3245		
	6x12".....	200-3250		
	6x14".....	200-3255		
Perimeter Cover	Size	Item #		
 	2.25x10".....	200-3100	4x10".....	200-3130
	2.25x12".....	200-3105	4x12".....	200-3135
	2.25x14".....	200-3110	4x14".....	200-3140
	3.25x10".....	200-3115	6x10".....	200-3145
	3.25x12".....	200-3120	6x12".....	200-3150
	3.25x14".....	200-3125	6x14".....	200-3155
Flue Bracket	Size	Item #		
 		<i>With Legs</i>	<i>With Bar</i>	
	3".....	382-1023.....	382-1003	
	4".....	382-1024.....	382-1004	
	5".....	382-1025.....	382-1005	
	6".....	382-1026.....	382-1006	
	8".....	382-1028.....	382-1008	

GUTTER&ROOFING







Gutter and roofing materials for commercial and residential needs



Yes We Can!

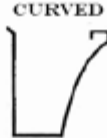

Phone (408) 275-6370
 Fax (408) 881-0177
 sales@acostamfg.com
 www.acostamfg.com

Gutter	Size	Item #																																																																																																					
<div data-bbox="110 499 219 573" style="border: 1px solid black; padding: 2px;"> PRIDE OF SMW 104 Production A-000001 </div> <div style="display: flex; justify-content: space-around; margin-top: 10px;"> <div style="text-align: center;">  <p>OG STYLE</p> </div> <div style="text-align: center;">  <p>PLAIN</p> </div> </div> <div style="text-align: center; margin-top: 10px;">  <p>CURVED</p> </div> <div style="display: flex; justify-content: space-around; margin-top: 10px;"> <div style="text-align: center;">  <p>TILE</p> </div> <div style="text-align: center;">  <p>DECCO</p> </div> </div>	<table border="0" style="width: 100%; border-collapse: collapse;"> <thead> <tr> <th style="width: 10%;"></th> <th style="width: 15%;"></th> <th style="width: 20%; text-align: center;">OG Style</th> <th style="width: 20%; text-align: center;">Plain</th> <th style="width: 20%; text-align: center;">Curved</th> <th style="width: 20%; text-align: center;">Decco</th> <th style="width: 20%; text-align: center;">Tile/Decco</th> </tr> </thead> <tbody> <tr> <td rowspan="3">4"</td> <td>20'.....</td> <td>700-0620</td> <td></td> <td></td> <td></td> <td></td> </tr> <tr> <td>25'.....</td> <td>700-0625</td> <td></td> <td></td> <td></td> <td></td> </tr> <tr> <td>30'.....</td> <td>700-0630</td> <td></td> <td></td> <td></td> <td></td> </tr> <tr> <td rowspan="3">5"</td> <td>20'.....</td> <td>700-1120</td> <td></td> <td></td> <td></td> <td></td> </tr> <tr> <td>25'.....</td> <td>700-1125</td> <td></td> <td></td> <td></td> <td></td> </tr> <tr> <td>30'.....</td> <td>700-1130</td> <td></td> <td></td> <td></td> <td></td> </tr> <tr> <td rowspan="3">5.25"</td> <td>20'.....</td> <td>701-0620</td> <td>701-1120</td> <td>701-1620</td> <td></td> <td></td> </tr> <tr> <td>25'.....</td> <td>701-0625</td> <td>701-1125</td> <td>701-1625</td> <td></td> <td></td> </tr> <tr> <td>30'.....</td> <td>701-0630</td> <td>701-1130</td> <td>701-1630</td> <td></td> <td></td> </tr> <tr> <td rowspan="3">6"</td> <td>20'.....</td> <td>700-1620</td> <td></td> <td></td> <td></td> <td></td> </tr> <tr> <td>25'.....</td> <td>700-1625</td> <td></td> <td></td> <td></td> <td></td> </tr> <tr> <td>30'.....</td> <td>700-1630</td> <td></td> <td></td> <td></td> <td></td> </tr> <tr> <td rowspan="3">7.25"</td> <td>20'.....</td> <td>702-0620</td> <td></td> <td>702-1620</td> <td></td> <td></td> </tr> <tr> <td>25'.....</td> <td>702-0625</td> <td>702-1125</td> <td>702-1625</td> <td>703-1625</td> <td></td> </tr> <tr> <td>30'.....</td> <td>702-0630</td> <td>702-1130</td> <td>702-1630</td> <td>703-1630</td> <td></td> </tr> </tbody> </table>			OG Style	Plain	Curved	Decco	Tile/Decco	4"	20'.....	700-0620					25'.....	700-0625					30'.....	700-0630					5"	20'.....	700-1120					25'.....	700-1125					30'.....	700-1130					5.25"	20'.....	701-0620	701-1120	701-1620			25'.....	701-0625	701-1125	701-1625			30'.....	701-0630	701-1130	701-1630			6"	20'.....	700-1620					25'.....	700-1625					30'.....	700-1630					7.25"	20'.....	702-0620		702-1620			25'.....	702-0625	702-1125	702-1625	703-1625		30'.....	702-0630	702-1130	702-1630	703-1630	
		OG Style	Plain	Curved	Decco	Tile/Decco																																																																																																	
4"	20'.....	700-0620																																																																																																					
	25'.....	700-0625																																																																																																					
	30'.....	700-0630																																																																																																					
5"	20'.....	700-1120																																																																																																					
	25'.....	700-1125																																																																																																					
	30'.....	700-1130																																																																																																					
5.25"	20'.....	701-0620	701-1120	701-1620																																																																																																			
	25'.....	701-0625	701-1125	701-1625																																																																																																			
	30'.....	701-0630	701-1130	701-1630																																																																																																			
6"	20'.....	700-1620																																																																																																					
	25'.....	700-1625																																																																																																					
	30'.....	700-1630																																																																																																					
7.25"	20'.....	702-0620		702-1620																																																																																																			
	25'.....	702-0625	702-1125	702-1625	703-1625																																																																																																		
	30'.....	702-0630	702-1130	702-1630	703-1630																																																																																																		
<div data-bbox="110 1350 219 1423" style="border: 1px solid black; padding: 2px;"> PRIDE OF SMW 104 Production A-000001 </div> <div style="display: flex; justify-content: space-around; margin-top: 10px;"> <div style="text-align: center;">  </div> </div> <div style="display: flex; justify-content: space-around; margin-top: 10px;"> <div style="text-align: center;">  </div> </div>	<table border="0" style="width: 100%; border-collapse: collapse;"> <thead> <tr> <th style="width: 10%;"></th> <th style="width: 15%;"></th> <th style="width: 20%; text-align: center;">OG Style</th> <th style="width: 20%; text-align: center;">Plain</th> <th style="width: 20%; text-align: center;">Curved</th> <th style="width: 20%; text-align: center;">Decco/Tile</th> </tr> </thead> <tbody> <tr> <td rowspan="2">4"</td> <td>Left.....</td> <td>709-0505</td> <td></td> <td></td> <td></td> </tr> <tr> <td>Right.....</td> <td>709-0506</td> <td></td> <td></td> <td></td> </tr> <tr> <td rowspan="2">5"</td> <td>Left.....</td> <td>709-0510</td> <td></td> <td></td> <td></td> </tr> <tr> <td>Right.....</td> <td>709-0511</td> <td></td> <td></td> <td></td> </tr> <tr> <td rowspan="2">5.25"</td> <td>Left.....</td> <td>709-0520</td> <td>709-0525</td> <td></td> <td></td> </tr> <tr> <td>Right.....</td> <td>709-0521</td> <td>709-0526</td> <td></td> <td></td> </tr> <tr> <td rowspan="2">6"</td> <td>Left.....</td> <td>709-0515</td> <td></td> <td></td> <td></td> </tr> <tr> <td>Right.....</td> <td>709-0516</td> <td></td> <td></td> <td></td> </tr> <tr> <td rowspan="2">7.25"</td> <td>Left.....</td> <td>709-0530</td> <td>709-0535</td> <td>709-0540</td> <td></td> </tr> <tr> <td>Right.....</td> <td>709-0531</td> <td>709-0536</td> <td>709-0541</td> <td></td> </tr> </tbody> </table>			OG Style	Plain	Curved	Decco/Tile	4"	Left.....	709-0505				Right.....	709-0506				5"	Left.....	709-0510				Right.....	709-0511				5.25"	Left.....	709-0520	709-0525			Right.....	709-0521	709-0526			6"	Left.....	709-0515				Right.....	709-0516				7.25"	Left.....	709-0530	709-0535	709-0540		Right.....	709-0531	709-0536	709-0541																																										
		OG Style	Plain	Curved	Decco/Tile																																																																																																		
4"	Left.....	709-0505																																																																																																					
	Right.....	709-0506																																																																																																					
5"	Left.....	709-0510																																																																																																					
	Right.....	709-0511																																																																																																					
5.25"	Left.....	709-0520	709-0525																																																																																																				
	Right.....	709-0521	709-0526																																																																																																				
6"	Left.....	709-0515																																																																																																					
	Right.....	709-0516																																																																																																					
7.25"	Left.....	709-0530	709-0535	709-0540																																																																																																			
	Right.....	709-0531	709-0536	709-0541																																																																																																			

Yes We Can!





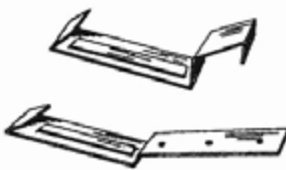
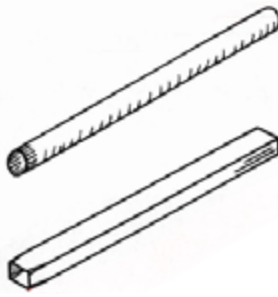

Phone (408) 275-6370
 Fax (408) 881-0177
 sales@acostamfg.com
 www.acostamfg.com

Gutter Strap	Size	Item #	
		<i>Hook</i>	<i>Nail</i>
	4" OG.....	709-1106.....	709-1006
	5" OG.....	709-1110.....	709-1010
	5.25".....	709-1105.....	709-1005
	6" OG.....	709-1115.....	709-1015
	7.25".....	709-1120.....	709-1020
	7.25" Tile.....		709-1025
	Leader/Conductor Pipe	Size	Item #
	<i>26 gauge Galvanized</i>		
	1.75"x 2.75".....	710-0510	
	2"x 3".....	710-1010	
	3"x 4".....	710-1510	
	2".....	712-0502	
	3".....	712-0503	
	4".....	712-0504	
	5".....	712-0505	
	6".....	712-0506	
	<i>26 gauge Bonderized</i>		
	1.75"x 2.75" 10'.....	710-0610	
	11'.....	710-0611	
	12'.....	710-0612	
	14'.....	710-0614	
	20'.....	710-0620	
	2"x 3".....	710-1110	
3"x 4".....	710-1610		

Yes We Can!

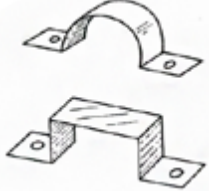

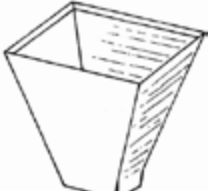

Phone (408) 275-6370
 Fax (408) 881-0177
 sales@acostamfg.com
 www.acostamfg.com

Conductor/Leader Pipe Strap	Size	Item #																						
 	1.75" x 2.75" 710-8005 2" x 3" 710-8010 3" x 4" 710-8015 2" 712-8002 3" 712-8003 4" 712-8004																							
Conductor Head	Size	Item #																						
 	1.75" x 2.75" to 4" x 6" 710-9010 1.75" x 2.75" to 6" x 8" 710-9012 2" x 3" to 6" x 8" 710-9020 3" x 4" to 6" x 8" 710-9030 1.75" x 2.75" to 9" x 9" 710-9014 3" x 4" to 8" x 10" 710-9032 3" x 4" to 10" x 12" 710-9034																							
Conductor Elbow	Size	Item #																						
	<table border="0"> <thead> <tr> <th></th> <th style="text-align: center;">45 degree</th> <th style="text-align: center;">75 degree</th> <th style="text-align: center;">90 degree</th> </tr> </thead> <tbody> <tr> <td>2"</td> <td style="text-align: center;">712-9402</td> <td style="text-align: center;">712-9702</td> <td style="text-align: center;">712-9902</td> </tr> <tr> <td>3"</td> <td style="text-align: center;">712-9403</td> <td style="text-align: center;">712-9703</td> <td style="text-align: center;">712-9903</td> </tr> <tr> <td>4"</td> <td style="text-align: center;">712-9404</td> <td style="text-align: center;">712-9704</td> <td></td> </tr> <tr> <td>1.75" x 2.75"</td> <td style="text-align: center;">712-9010</td> <td style="text-align: center;">712-9011</td> <td style="text-align: center;">712-9012</td> </tr> </tbody> </table>		45 degree	75 degree	90 degree	2"	712-9402	712-9702	712-9902	3"	712-9403	712-9703	712-9903	4"	712-9404	712-9704		1.75" x 2.75"	712-9010	712-9011	712-9012			
	45 degree	75 degree	90 degree																					
2"	712-9402	712-9702	712-9902																					
3"	712-9403	712-9703	712-9903																					
4"	712-9404	712-9704																						
1.75" x 2.75"	712-9010	712-9011	712-9012																					
Drop Outlet	Size	Item #																						
	2" Tapered 709-3010 3" K Style Tapered 709-3011																							

Phone (408) 275-6370
 Fax (408) 881-0177
 sales@acostamfg.com
 www.acostamfg.com



Code Cap Base	Size	Item #		
  		<i>All pitch (0-5/12)</i>		<i>All pitch (6/12-12/12)</i>
		<i>Regular</i>	<i>Shake</i>	<i>Shake</i>
	3"	410-0310	410-0315	410-0316
	4"	410-0410	410-0415	410-0416
	5"	410-0510	410-0515	410-0516
	6"	410-0610	410-0615	410-0616
	7"	410-0710	410-0715	410-0716
	8"	410-0810	410-0815	410-0816
	10"	410-1010	410-1015	
	12"	410-1210	410-1215	
	<i>Oval</i>			
	4" (Horizontal)	410-2410	410-2415	
	4" (Vertical)	410-2411	410-2416	
	6" (Horizontal)	410-2610	410-2615	
	6" (Vertical)	410-2611	410-2616	
	Made to Order:			
	Kick for Tile			
	<ul style="list-style-type: none"> Entire piece made from 0.025 Aluminum 			
	Lead Base			
	3"	410-0325		
	4"	410-0425		
	5"	410-0525		
	6"	410-0625		
	7"	410-0725		
	8"	410-0825		
	10"	410-1025		
	4" Oval (Horizontal)	410-2425		
	4" Oval (Vertical)	410-2426		
	6" Oval (Horizontal)	410-2625		
	6" Oval (Vertical)	410-2626		
	<ul style="list-style-type: none"> Adjustable 0 to 5/12 Code Cap connector made from 0.025 Aluminum 2# (pound) lead or 0.025 Aluminum used for base I.C.B.O. ES-ER No 3211 			

Yes We Can!

Acosta

Sheet Metal Manufacturing, Inc.

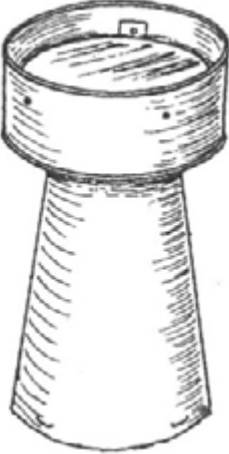
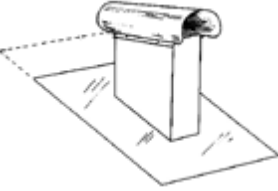

Phone (408) 275-6370
 Fax (408) 881-0177
 sales@acostamfg.com
 www.acostamfg.com

Code Cap Top	Size		Item #	
<div data-bbox="110 510 212 575" style="border: 1px solid black; padding: 2px;"> PRIDE OF SMW 104 Production A-000001 </div> 	3".....		410-0305	
	4".....		410-0405	
	5".....		410-0505	
	6".....		410-0605	
	7".....		410-0705	
	8".....		410-0805	
	10".....		410-1005	
	12".....		410-1205	
	<i>Oval</i>			
	4".....		410-2405	
	6".....		410-2605	
	<ul style="list-style-type: none"> • I.C.B.O. ES-ER No 3211 • Entire piece made from 0.025 Aluminum 			
	Roof Jack (Square Top)	Size		Item #
	<div data-bbox="110 1314 212 1379" style="border: 1px solid black; padding: 2px;"> PRIDE OF SMW 104 Production A-000001 </div> 	<i>Flat</i>		<i>Regular Base</i>
		<i>Shake Base</i>		
		<i>Horizontal</i>	<i>Horizontal</i>	
4"x10".....		450-0005.....	450-1405.....	450-2405
4"x12".....		450-0010.....	450-1410.....	450-2410
4"x14".....		450-0015.....	450-1415.....	450-2415
			<i>Vertical</i>	<i>Vertical</i>
4"x10".....			450-1420.....	450-2420
4"x12".....			450-1425.....	450-2425
4"x14".....			450-1430.....	450-2430



Yes We Can!

Acosta

Sheet Metal Manufacturing, Inc.

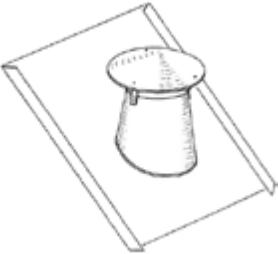

Phone (408) 275-6370
 Fax (408) 881-0177
 sales@acostamfg.com
 www.acostamfg.com

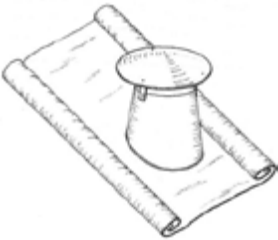
Roof Jack/Fan Jack (Kick Base)	Size	Item #			
 		4/12	5/12	6/12	
	4".....	455-3404.....	455-3504.....	455-3604	
	6".....	455-3406.....	455-3506.....	455-3606	
	8".....	455-3408.....	455-3508.....	455-3608	
	10".....	455-3410			
	12".....	455-3412			
	14".....	455-3414			
Roof Jack/Fan Jack (Lead Base)	Size	Item #			
 		4/12	5/12	6/12	
	4".....	455-4404.....	455-4504.....	455-4604	
	6".....	455-4406.....	455-4506.....	455-4606	
	8".....	455-4408.....	455-4508.....	455-4608	
	Made to Order:				
	5" 7" 10" 12" 14"				



Yes We Can!

Acosta

Sheet Metal Manufacturing, Inc.

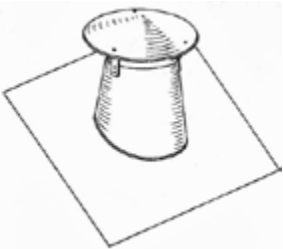
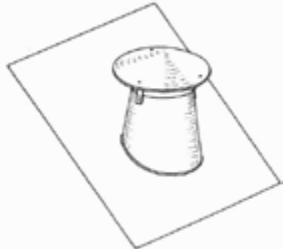

Phone (408) 275-6370
 Fax (408) 881-0177
 sales@acostamfg.com
 www.acostamfg.com

<p>Roof Jack/Fan Jack (Regular Base)</p>	<p>Size Item #</p>
<p>PRIDE OF SMW 104 Production A-000001</p> 	<p style="text-align: center;"><i>Flat 4/12 5/12 6/12</i></p> <p>4".....455-0004.....455-1404.....455-1504.....455-1604 6".....455-0006.....455-1406.....455-1506.....455-1606 8".....455-0008.....455-1408.....455-1508.....455-1608 10".....455-0010.....Made to Order 12".....455-0012.....Made to Order 14".....455-0014.....Made to Order</p> <p>Made to Order: 5" 7"</p> <ul style="list-style-type: none"> • 26 gauge Galvanized* Steel base plate and cap • F.H.A. plate
<p>Roof Jack/Fan Jack (Shake Base)</p>	<p>Size Item #</p>
<p>PRIDE OF SMW 104 Production A-000001</p> 	<p style="text-align: center;"><i>4/12 5/12 6/12</i></p> <p>4".....455-2404.....455-2504.....455-2604 6".....455-2406.....455-2506.....455-2606 8".....455-2408.....455-2508.....455-2608</p> <p>Made to Order: 5" 7" 10" 12" 14"</p> <ul style="list-style-type: none"> • 26 gauge Galvanized* Steel base plate and cap • F.H.A. plate
<p>Roof Safe</p>	<p>Size Item #</p>
	<p>8" x 8" (3 Piece).....410-0000</p>

Yes We Can!

Acosta

Sheet Metal Manufacturing, Inc.

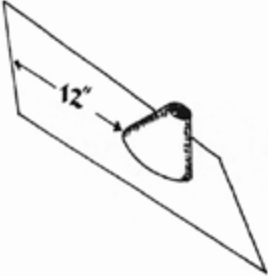
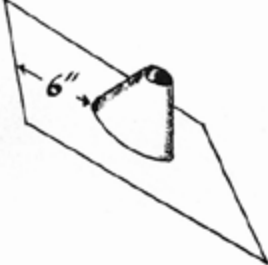

Phone (408) 275-6370
 Fax (408) 881-0177
 sales@acostamfg.com
 www.acostamfg.com

Roof Flashing (Flat)	Size	Item #		
		Flat Base	Regular Base	Shake Base
 	0.5"	440-0003	440-1003	440-1503
	0.75"	440-0006	440-1006	440-1506
	1"	440-0009	440-1009	440-1509
	1.5"	440-0012	440-1012	440-1512
	2"	440-0015	440-1015	440-1515
	2.5"	440-0018	440-1018	440-1518
	3"	440-0021	440-1021	440-1521
	3" D.W.		440-1023	440-1523
	4"	440-0024	440-1024	440-1524
	4" D.W.		440-1026	440-1526
	5"	440-0027	440-1027	440-1527
	5" D.W.		440-1029	440-1529
	6"	440-0030	440-1030	440-1530
	6" D.W.		440-1032	440-1532
	7"	440-0033	440-1033	440-1533
	8"	440-0036	440-1036	440-1536
	8" D.W.		440-1038	440-1538
	9"		440-1039	440-1539
	10"	440-0042	440-1042	440-1542
	12"	440-0045	440-1045	440-1545
	14"	440-0048	440-1048	440-1548
	16"	440-0051		
	18"	440-0054		
	20"	440-0057		
22"	440-0060			
24"	440-0063			

- Adjustable pitch 0 to 5/12
- "Flat" is for a no pitch roof only
- 6" base all sides
- F.H.A. plate
- Made with 26 gauge Galvanized Steel
- Kick for Tile base: made to order

Yes We Can!



Phone (408) 275-6370
 Fax (408) 881-0177
 sales@acostamfg.com
 www.acostamfg.com

Roof Flashing (Pitch)	Size	Item #
<div data-bbox="110 506 219 573" style="border: 1px solid black; padding: 2px;"> PRIDE OF SMW 104 Production A-000001 </div> <div data-bbox="105 814 381 1071" style="text-align: center;"> <p>A technical drawing of a roof flashing component, showing a conical shape with a flange and a central hole, mounted on a rectangular base.</p> </div>	Shake Base	
	0.5".....	440-3503
	0.75".....	440-3506
	1".....	440-3509
	1.5".....	440-3512
	2".....	440-3515
	2.5".....	440-3518
	3".....	440-3521
	3" D.W.....	440-3523
	4".....	440-3524
	4" D.W.....	440-3526
	5".....	440-3527
	5" D.W.....	440-3529
	6".....	440-3530
	6" D.W.....	440-3532
	7".....	440-3533
	7" D.W.....	440-3535
	8".....	440-3536
	8" D.W.....	440-3538
	<ul style="list-style-type: none"> • Adjustable 6/12 to 12/12 • F.H.A. plate 	



Yes We Can!

Acosta

Sheet Metal Manufacturing, Inc.

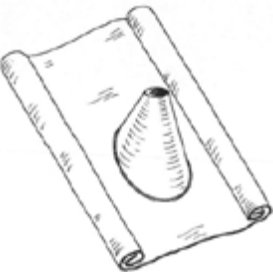

Phone (408) 275-6370
 Fax (408) 881-0177
 sales@acostamfg.com
 www.acostamfg.com

Roof Flashing (Lead Base)	Size Item #
 	<i>All pitch (0-5/12)</i>
	<i>Single Wall Double Wall</i>
	0.5".....440-2503
	0.75".....440-2506
	1".....440-2509
	1.5".....440-2512
	2".....440-2515
	2.5".....440-2518
	3".....440-2521.....440-2523
	4".....440-2524.....440-2526
	5".....440-2527.....440-2529
	6".....440-2530.....440-2532
	7".....440-2533
	8".....440-2536.....440-2538
	Made to Order
10"	
12"	
14"	
China Cap	Size Item #
 	4".....480-0604
	5".....480-0605
	6".....480-0606
	7".....480-0607
	8".....480-0608
	10".....480-0610
	12".....480-0612
	14".....480-0614
	16".....480-0616
	18".....480-0618
	20".....480-0620
	22".....480-0622
	24".....480-0624
<ul style="list-style-type: none"> • <i>Designed for single wall pipe</i> 	

Yes We Can!

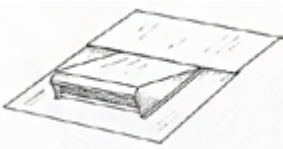

Phone (408) 275-6370
Fax (408) 881-0177
sales@acostamfg.com
www.acostamfg.com

Eyebrow Vent	Size	Item #
 	26 Gauge Regular Base.....	500-5005
	26 Gauge Shake Base.....	500-5010
	Lead Base.....	500-5020
	Made to Order:	
	Kick for Tile	





Yes We Can!

Acosta

Sheet Metal Manufacturing, Inc.

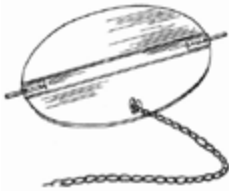

Phone (408) 275-6370
 Fax (408) 881-0177
 sales@acostamfg.com
 www.acostamfg.com

Gravity Vent	Size	Item #			
		Top	Base	Damper with Chain	
   	26 Gauge				
	8"	500-0508	500-0608	500-0708	
	10"	500-0510	500-0610	500-0710	
	12"	500-0512	500-0612	500-0712	
	14"	500-0514	500-0614	500-0714	
	16"	500-0516	500-0616	500-0716	
	24 Gauge				
	18"	500-0518	500-0618	500-0718	
	20"	500-0520	500-0620	500-0720	
	22"	500-0522	500-0622	500-0722	
	24"	500-0524	500-0624	500-0724	
	26"	500-0526	500-0626	500-0726	
	28"	500-0528	500-0628	500-0728	
	30"	500-0530	500-0630	500-0730	
	Storm Collar	Size	Item #		
	 	4"	480-1004		
		6"	480-1006		
		8"	480-1008		
10"		480-1010			
12"		480-1012			
14"		480-1014			
16"		480-1016			
18"		480-1018			
20"		480-1020			
22"		480-1022			
24"		480-1024			

Yes We Can!

Acosta

Sheet Metal Manufacturing, Inc.



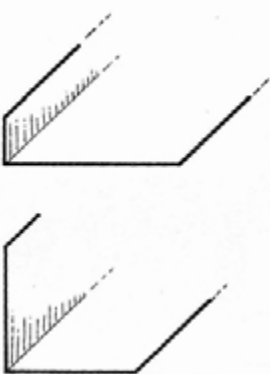
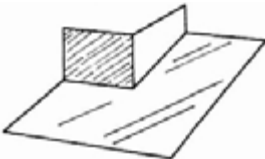
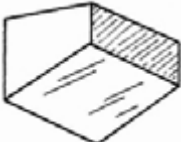

Phone (408) 275-6370
 Fax (408) 881-0177
 sales@acostamfg.com
 www.acostamfg.com

Angle Flashing 90 Degree	Size	Item #			
 <p>PRIDE OF SMW 104 Production A-000001</p>		26 Gauge	22 Gauge	18 Gauge	16 Gauge
	1" x 3".....	600-3044			
	1" x 4".....	600-3048			
	1.5" x 1.5".....	600-3004.....		600-3008.....	600-3012
	2" x 2".....	600-3016.....	600-3020.....	600-3024.....	600-3028
	3" x 3".....	600-3032			
	3" x 6".....	600-3052			
	4" x 4".....	600-3036			
	4" x 6".....	600-3056			
	4" x 12".....	600-3060			
	4" x 14".....	600-3064			
	6" x 6".....	600-3040			
Corner	Size	Item #			
 <p>PRIDE OF SMW 104 Production A-000001</p>		Upper Left	Lower Left	Upper Right	Lower Right
	4/12.....	600-4024.....	600-4064.....	600-4044.....	600-4084
	5/12.....	600-4025.....	600-4065.....	600-4045.....	600-4085
	6/12.....	600-4026.....	600-4066.....	600-4046.....	600-4086
Inside Corner	Size	Item #			
 <p>PRIDE OF SMW 104 Production A-000001</p>	4/12.....	600-4004			
	5/12.....	600-4005			
	6/12.....	600-4006			
	<ul style="list-style-type: none"> • All joints 50/50 soldered • Spot welded and soldered • Available in 2# (pound) and 4# (pound) lead base 				

Yes We Can!

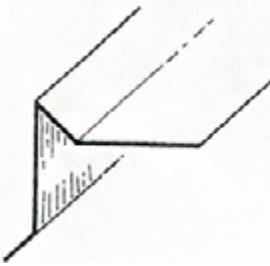

Phone (408) 275-6370
 Fax (408) 881-0177
 sales@acostamfg.com
 www.acostamfg.com

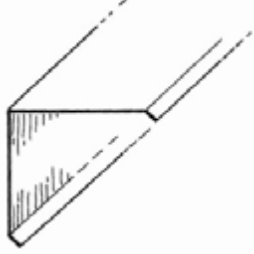
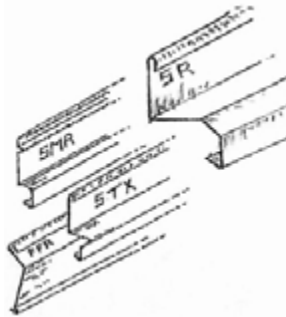
Gravel Stop	Size	Item #	
 		<i>With Kick</i>	<i>With Grip</i>
	2"x 2".....	600-0620.....	600-0520
	3"x 3".....	600-0630.....	600-0530
Nosing	Size	Item #	
 		<i>With Kick</i>	<i>With Grip</i>
	1.5"x 1.5".....	600-1110.....	600-1010
	2"x 2".....	600-1115.....	600-1015
	3"x 3".....	600-1120.....	600-1020
Reglet	Size	Item #	
	Surface Mount.....	600-5505	
	Stucco.....	600-5510	
	Flashing.....	600-5515	

Yes We Can!



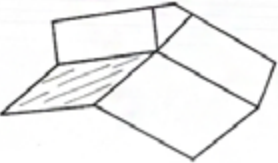
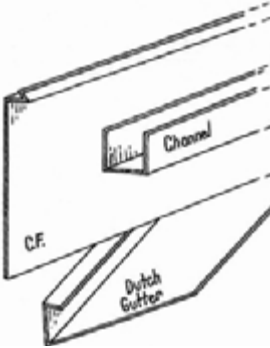
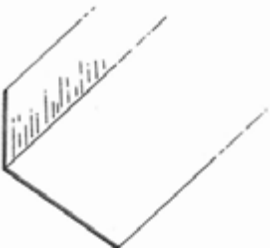

Phone (408) 275-6370
 Fax (408) 881-0177
 sales@acostamfg.com
 www.acostamfg.com

Ridge Flashing	Size	Item #
<div data-bbox="110 506 212 573" style="border: 1px solid black; padding: 2px;"> PRIDE OF SMW104 Production A-000001 </div> 	4/12.....600-5004 5/12.....600-5005 6/12.....600-5006	
Roofing Metals	Size	Item #
		Tile Pan Flashing (4"x 7"x 1").....600-8505 Dutch Gutter (Rain Diverter).....600-6510 Termite Flashing (4"x 8"x 1").....600-8515 6" Counter Flashing.....600-6010 90 Degree Channel (1"x 1.125"x 1").....600-7010
Roof to Wall	Size	Item #
<div data-bbox="110 1564 212 1631" style="border: 1px solid black; padding: 2px;"> PRIDE OF SMW104 Production A-000001 </div> 		<p style="text-align: center;">4x6</p> 4/12.....600-2404 5/12.....600-2405 6/12.....600-2406

Yes We Can!

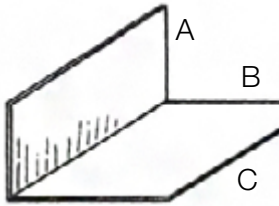

Phone (408) 275-6370
 Fax (408) 881-0177
 sales@acostamfg.com
 www.acostamfg.com

Step Shingle	Size	Item #
 <p>PRIDE OF SMW 104 Production A-000001</p>	<p>AxBxC</p> <p>3"x 5"x 7".....600-8005</p> <p>4"x 5"x 7".....600-8010</p> <p>4"x 6"x 12".....600-8015</p> <p>4"x 6"x 14".....600-8020</p>	
W Valley	Size	Item #
 <p>PRIDE OF SMW 104 Production A-000001</p>	<p>10' Long</p> <p>18".....600-1505</p> <p>24".....600-1510</p> <p>24" for Tile.....600-1515</p>	
Z-Bar	Size	Item #
 <p>PRIDE OF SMW 104 Production A-000001</p>	<p>1"x 3/8"x 1/2".....600-7510</p> <p>1"x 5/8"x 1/2".....600-7515</p> <p>2"x 1 1/2"x 1/2".....600-7520</p>	

This page intentionally left blank

ASSORTED ACCESSORIES



Assorted metals and accessories for commercial and residential needs



Yes We Can!

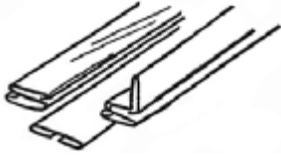

Phone (408) 275-6370
 Fax (408) 881-0177
 sales@acostamfg.com
 www.acostamfg.com

"S" and Drive Clip	Size	Item #
 		Galvanized 304 2B Stainless Steel
	"S" Clip 120" long.....	270-3005.....270-3301
	"D"/Drive Clip 120" long.....	270-3205.....270-3302
	Standing "S" Clip 120" long.....	270-3105
Duct Liner and Pins	Size	Item #
	0.5"x 48"x 100 feet.....	300-0505
	1"x 48"x 100 feet.....	300-0510
	1"x 60"x 100 feet.....	300-0511
	1.5"x 48"x 50 feet.....	300-0513
	1.5"x 60"x 50 feet.....	300-0514
	1"x 47"x 100 feet.....	301-4710
	1"x 59"x 100 feet.....	301-5910
	1.5"x 59"x 50 feet.....	301-5915
Duro Dyne Accessories	Size	Item #
	Ductmate 35 in in 10' lengths.....	270-2006/ per foot
	Ductmate 35 in 20' lengths.....	270-2005 /per foot
	Ductmate Corners 111 A.....	270-2105 /each
	Ductmate Gasket roll 25' long.....	270-2205 /per roll
	Ductmate PVC Cleats 6" long.....	270-2110 /each
	TDC Metal Cleats.....	270-2111 /each
	TDC Flex Connector (4x4x4) 100' long.....	270-6006 /per box
	Flex Connector (3x3x3) 100' long.....	270-6005 /per box
	Ductmate Metal Cleats 6" long.....	270-2112 /each
	2" Turning Vane.....	270-1005 /per foot
	4" Turning Vane.....	270-1006 /per foot
	2" Turning Vane Rail.....	270-1105 /per foot
4" Turning Vane Rail.....	270-1106 /per foot	

Yes We Can!

Acosta

Sheet Metal Manufacturing, Inc.

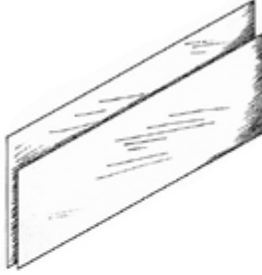
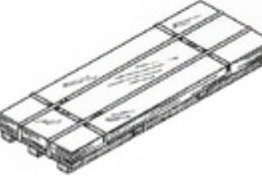

Phone (408) 275-6370
 Fax (408) 881-0177
 sales@acostamfg.com
 www.acostamfg.com

Flat Sheet	Size	Item #				
		Galvanized	304 2B Stainless	316 2B Stainless	#4 PVC Stainless	Bonderized
 	36"x 120":					
	30 Gauge....	280-1025				
	28 Gauge....	280-1136				
	26 Gauge....	280-1236.....	812-6010			
	24 Gauge....	280-1336.....	812-5010			
	22 Gauge....	280-1436.....	812-4010.....		812-4020	
	20 Gauge....	280-1536.....	812-3010.....		812-3020	
	48"x 120":					
	28 Gauge....	280-1148				
	26 Gauge....	280-1248.....	812-6030.....			811-6030
	24 Gauge....	280-1348.....	812-5030.....	812-5050.....	812-5040.....	811-5030
	22 Gauge....	280-1448.....	812-4030.....	812-4050.....	812-4040	
	20 Gauge....	280-1548.....	812-3030.....	812-3050.....	812-3040	
	18 Gauge....	4812018.....	812-2030.....		812-2040	
	16 Gauge....	810-1030.....	812-1030.....		812-1040	
	14 Gauge....	810-0030				
	12 Gauge....	810-0020		Aluminum: (48" x 120")		
	10 Gauge....	810-0010		0.032.....	814-2030	
				0.025.....	814-2530	
				0.050.....	814-3030	
				0.063.....	814-4030	
	26 Gauge:					
	4"x 120"....	280-1204		Cold Rolled: (48" x 120")		
	6"x 120"....	280-1206		16 Gauge.....	816-1030	
	8"x 120"....	280-1208		18 Gauge.....	816-2030	
	9"x 120"....	280-1209		Jet Coat: (48" x 120")		
	10"x 120"....	280-1210		22 Gauge.....	811-4030	
	12"x 120"....	280-1212		24 Gauge.....	811-3030	
	18"x 120"....	280-1218		Galvanized: (60"x 120")		
	24"x 120"....	280-1224		26 Gauge.....	280-1260	
	24 Gauge:			24 Gauge.....	280-1360	
	24"x 24"....	280-1265		22 Gauge.....	280-1460	
24"x 48"....	280-1266		20 Gauge.....	280-1560		
48"x 48"....	280-1275		18 Gauge.....	810-2080		
48"x 60"....	280-1276		16 Gauge.....	810-1080		



Yes We Can!

Acosta

Sheet Metal Manufacturing, Inc.

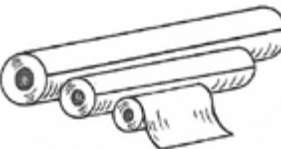

Phone (408) 275-6370
 Fax (408) 881-0177
 sales@acostamfg.com
 www.acostamfg.com

Insulation (Rolls)	Size	Item #
	<i>Fiber Glass</i>	
	9"x 150 feet.....	300-1005
	12"x 150 feet.....	300-1010
	36"x 150 feet.....	300-1015
	<i>Foil Back Insulation</i>	
	48"x 100 feet.....	300-1505
	(Astrofoil) 48"x 50 feet.....	300-1510
Lead Rolls	Size	Item #
	<i>2# (pound)</i>	
	9.625"x 240".....	266-0509
	12"x 240".....	266-0512
	24"x 240".....	266-0524
	48"x 240".....	266-0548
	<i>4# (pound)</i>	
	30"x 300".....	266-0618
Screws and Panduit Strap	Size	Item #
	Zip Screws #8: 0.5" (1,000).....	270-0505 /per box
	Self Tapping Screws #8: 0.5" (1,000).....	270-0510 /per box
	Self Tapping Screws #10: 3/4" (1,000).....	270-0511 /per box
	Ductmate Nuts and Bolts (100).....	840-2012 /per box
	Panduit Straps 36" (50 piece per bag).....	250-0036 /per bag
	Panduit Straps 48" (50 pieces per bag).....	250-0048 /per bag

Yes We Can!

Acosta

Sheet Metal Manufacturing, Inc.



Phone (408) 275-6370
 Fax (408) 881-0177
 sales@acostamfg.com
 www.acostamfg.com

Sealant and Solder	Size	Item #
	5/16 Tri-bar Solder	
	Stick.....	265-0505
	50 pound box.....	265-0510
	Sal Ammoniac.....	265-5005
	Sealant:	
	Sikaflex.....	255-0000
	DP1010	
	Tube.....	255-0510
	1 Gallon Tub.....	255-0505
	DP1020	
1 Gallon Tub.....	255-0506	
Strap	Size	Item #
	1" x 60 Feet Roll 22 Gauge.....	290-1022 /per box
	1.5" x 100 Feet Roll 26 Gauge.....	290-1526 /per box
	1" x 10 Feet Long 22 Gauge.....	290-0022 /per foot
	1" x 10 Feet Long 18 Gauge.....	290-0018 /per foot
	1.5" x 10 Feet Long 24 Gauge.....	290-1524 /per foot
	1.5" x 10 Feet Long 22 Gauge.....	290-1522 /per foot
Tape, Glue, Visqueen, Accessories	Size	Item #
	<i>Duct Tape</i>	
	2" x 180 feet (398) Grey	250-0020
	2" x 360 feet (555 U.L.) Black	250-0021
	2" x 360 feet (555 U.L.) Silver	250-0023
	2" x 180 feet (557 U.L.) Black.....	250-0022
	2" x 180 feet (558 U.L. 181-B) Silver.....	250-0024
	<i>Foil Tape</i>	
	2" x 150 feet.....	250-1020
	2.5" x 180 feet (181A U.L.).....	250-1030
	3" x 150 feet (FSK).....	250-2030
	2" x 50 feet (BUTYL).....	250-3020
	<i>Glue: 357 Spray Adhesive Glue.....</i>	270-8005
	Visqueen 24" x 200 Feet Long	270-1000
	1" Paint Brush	880-0025
2" Paint Brush	880-0026	

Yes We Can!

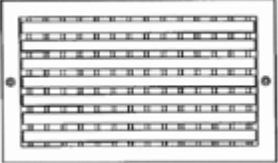
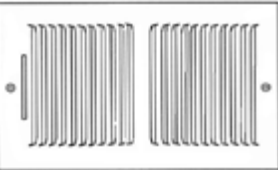
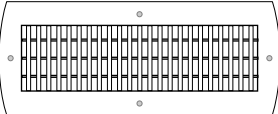

Phone (408) 275-6370
 Fax (408) 881-0177
 sales@acostamfg.com
 www.acostamfg.com

Ceiling Register (Shoemaker)	Size	Item #
		
	10" x 10".....	501-2046
	12" x 12".....	501-2047
Wall-Ceiling Register (Shoemaker)	Size	Item #
	10" x 4".....	501-2040
	10" x 6".....	501-2041
	12" x 6".....	501-2042
	14" x 6".....	501-2043
	12" x 8".....	501-2044
	14" x 8".....	501-2045
	12" x 4".....	501-2048
	14" x 4".....	501-2049
	Spiral Double Grille (Shoemaker)	Size
	10" x 4" on 8".....	501-4001
	10" x 6" on 10".....	501-4002
	12" x 4" on 8".....	501-4003
	12" x 6" on 10".....	501-4004
	14" x 4" on 8".....	501-4005
	14" x 6" on 10".....	501-4006
	14" x 8" on 12".....	501-4007
	16" x 6" on 10".....	501-4008
	16" x 8" on 12".....	501-4009

Yes We Can!

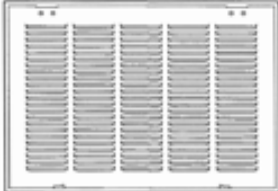
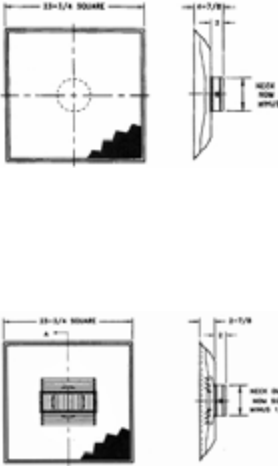

Phone (408) 275-6370
 Fax (408) 881-0177
 sales@acostamfg.com
 www.acostamfg.com

Return-Air Filter Grille (Shoemaker)	Size	Item #			
	14"x 14"	501-3014			
	20"x 14"	501-3020			
	24"x 14"	501-3024			
	25"x 14"	501-3025			
T-Bar (Return and Supply Air)	Size	Item #			
		<table border="0"> <thead> <tr> <th></th> <th><i>Return</i></th> <th><i>Supply</i></th> </tr> </thead> </table>		<i>Return</i>	<i>Supply</i>
		<i>Return</i>	<i>Supply</i>		
	6"	501-3032	501-2054		
	8"	501-3031	501-2053		
	10"	501-3026	501-2050		
	12"	501-3027	501-2051		
	14"	501-3028	501-2052		
	16"	501-3029			
	18"	501-3030			

Yes We Can!

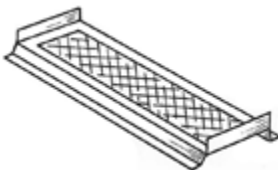
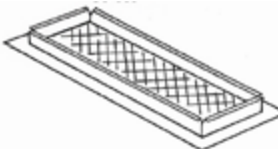
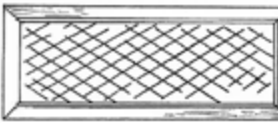

Phone (408) 275-6370
 Fax (408) 881-0177
 sales@acostamfg.com
 www.acostamfg.com

Eave Vent	Size	Item #
	3.5" x 14".....	500-7005
	3.5" x 22".....	500-7010
	5.5" x 14".....	500-7015
	5.5" x 22".....	500-7020
	7.5" x 14".....	500-7025
	7.5" x 22".....	500-7030
Foundation Vent (Stucco)	Size	Item #
	1/4" Mesh	
	14" x 4".....	500-8014
	14" x 6".....	500-8016
	14" x 8".....	500-8018
Foundation Vent (Flat)	Size	Item #
	1/4" Mesh	
	14" x 4".....	500-8004
	14" x 6".....	500-8006
	14" x 8".....	500-8008



Yes We Can!

Acosta

Sheet Metal Manufacturing, Inc.

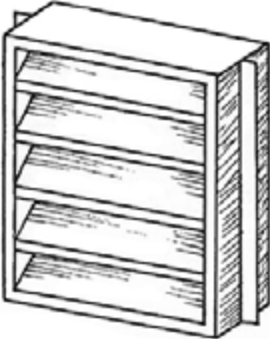

Phone (408) 275-6370
 Fax (408) 881-0177
 sales@acostamfg.com
 www.acostamfg.com

Gable Vent	Size	Item #
	14" x 8"	500-6008
	14" x 12"	500-6012
	14" x 18"	500-6018
	14" x 24"	500-6024
Floor Vent (Shoemaker)	Size	Item #
	<i>Toe Kick</i>	
	2.25" x 14"	501-1024
	<i>Floor Register</i>	
	4" x 10"	501-1040
	4" x 12"	501-1042
4" x 14"	501-1044	

This page intentionally left blank

Index

Acoustical Flex (with or without Damper)	8
Adjustable Elbows	28-29
Aluma Flex (Insulated or Bare)	9
Alumasprial Pipe	9
Angle Flashing (90 Degree)	66
Assorted Accessories	72-80
Blast Gate Damper	42
Ceiling Box (Rectangular/Square)	40
Ceiling Register (Shoemaker)	76
China Cap	63
Code Cap Bases	57
Code Cap Top	58
Collar	41
Collar with Damper	42
Conductor Elbow	56
Conductor Head	56
Leader/Conductor Pipe	55
Conductor/Leader Pipe Strap	56
Conical Tap	34
Corner	66
Damper Blade/Disc	42
Draft Diverter	63
Drive Clip and "S" Clip	72
Drop Outlet	56
Dryer Vent	52
Duct Liner and Pins	72
Duraflange	21
Duravent	10
Duro Dyne Accessories	72
Dust Cover	52
Eave Vent	78
Elbows	28-31
Adjustable (45 and 90 Degree)	28-29
Long Radius Adjustable (45 and 90 Degree)	30
Spiral Elbow (45 and 90 Degree)	18, 30
Spot and Sealed (22.5, 45, and 90 Degree)	31
End Cap (Round)	43
Eyebrow Vent	64
F-1 Single Register Box	50

Index

F-5 Straight Boot	46
F-13 Angle Boot 90 Degree	46
F-17 Cone Boot	46
Fan Boot	47
Fan Jacks/Roof Jacks	58-60
Square Top	58
Kick Base	59
Lead Base	59
Regular Base	60
Shake Base	60
Flat Sheets	73
Floor Vent (Shoemaker)	79
Flue Bracket.....	52
Foundation Vents	
Stucco	78
Flat	78
Fresh Air Vents	50
Furnace Pipe	11-12
KD/Snap Lock	11
Stitch Welded	12
Gable Vent	79
Gravel Stop	67
Gravity Vent	64
Gravity Vent Damper with Chain	65
Gutter	54
Gutter and Roofing Products	54-69
Gutter end Cap	54
Gutter Strap	55
Hanger Strap	21
HVAC Fittings and Accessories	40-52
Inside Corner	66
Insulation (Rolls)	74
Leader/Conductor Pipe	55
Lead Rolls	74
Nosing	67
Perimeter Box	49
Perimeter Cover	52
PH 1	47
PH 2	48

Index

PH 2A	48
PH 3	49
Pipe	8-15
Plenum and Cap	12
Rain Hoods	51
“Old Style”	51
For wood	51
For stucco	51
Reducer	43
Reglet	67
Return-Air Filter Grille (Shoemaker)	77
Ridge Flashing	68
Riser Elbow	50
Riser Pipe	12
Roof Flashings	61-62
Flat	61
Pitch	62
Lead Base	62
Roofing Metals	68
Roof Jacks/Fan Jacks	58-60
Square Top	58
Kick Base	59
Lead Base	59
Regular Base	60
Shake Base	60
Roof Safe	60
Roof to Wall	68
Saddle Tap (Rectangular)	34
Saddle Tee	35
Saddle Wye	36
“S” and Drive Clip	72
Screws and Panduit Strap	74
Sealant and Solder	75
Self Stick Collar	34, 41
Spiral Products	18-25
Spiral Pipe	13-14
Spiral Elbow (45, and 90 Degree)	18, 30
Spiral Collar	19
Spiral Double Grille (Shoemaker)	76

Index

Spiral End Cap	20
Spiral Pipe	22-23
Spiral-Helix Ovalizer Chart	24-25
Square to Round	45
Step Shingle	69
Strap	75
Stock Wye Branches	37
Storm Collar	65
Tape, Glue, and Visqueen	75
Taper	44
Taper with Collar	44
Taper with Collar (for Spiral)	20, 45
Tee	35
Tees	34-37
T-Bar (Return and Supply Air)	77
Vent Tee	35
Vent Wye	36
Wall-Ceiling Register (Shoemaker)	76
Wire Flex (with or without collars)	15
W Valley	69
Wyes	34-37
Z-Bar	69

This page intentionally left blank

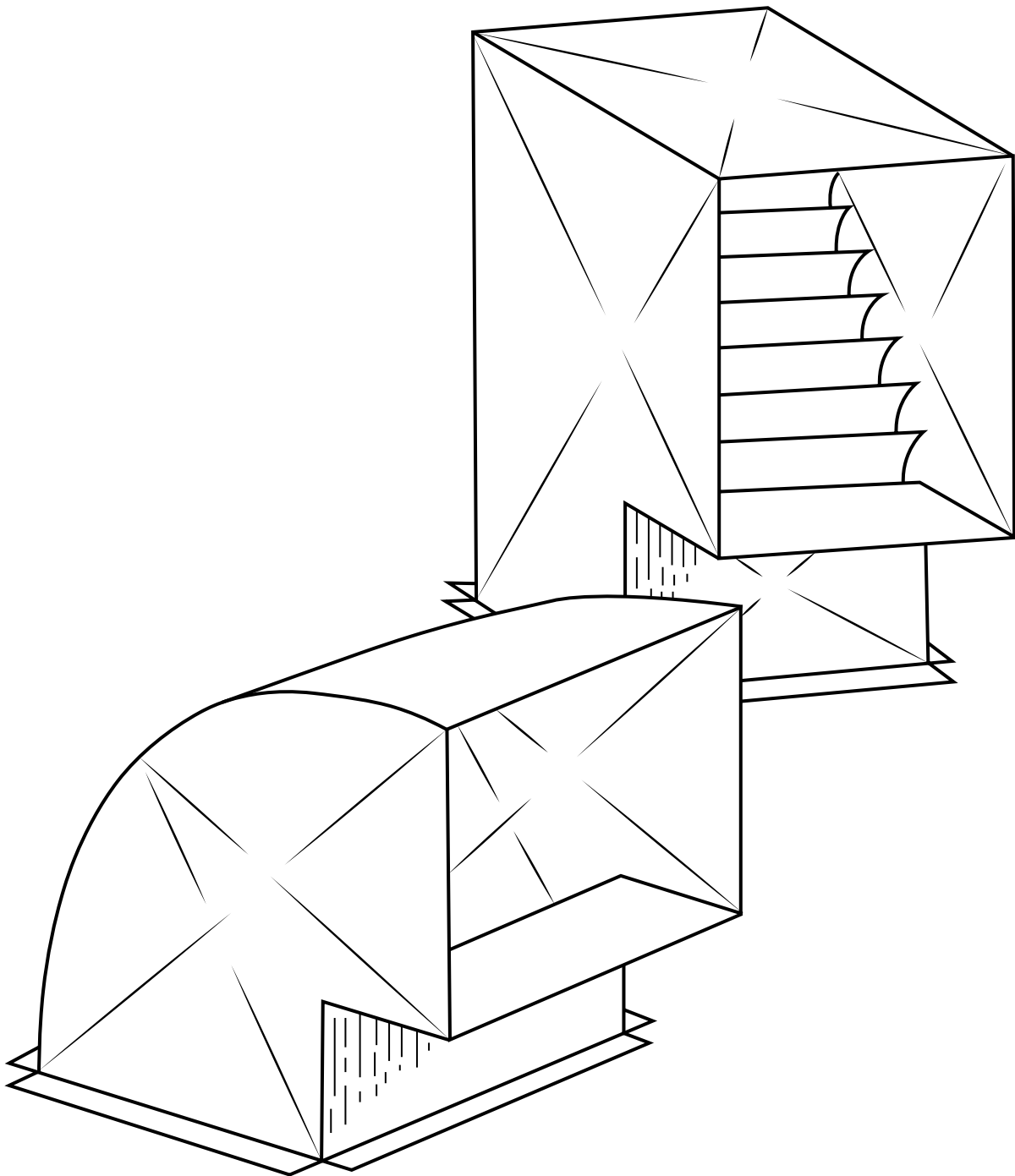

Product Catalog ©2024

www.acostamfg.com | 930 Remillard Court. San Jose, California 95122 | sales@acostamfg.com